



# **SERIES II ELECTRONIC VENDERS**

**First Production xxxx-6111AR  
January 1993**

**Operation Manual  
Set-Up  
Configuration  
Troubleshooting  
Parts**

Revised January 17, 1996

803,902,520.01

# TABLE OF CONTENTS

General Information.....	Pages 3 through 6
Installation & Set-Up.....	Pages 7 through 11
Hardware Configuration & Features.....	Pages 12 through 14
SIID Audit Features .....	Pages 15 through 17
Controller Programming.....	Pages 18 through 28
Programming Quick Reference .....	Page 29
Electrical Parts & Their Functions.....	Pages 30 through 34
Product Shimming.....	Page 35
Adjustments: Cams/Rear Spacers.....	Pages 36 through 39
General Maintenance .....	Pages 40 and 41
Trouble Shooting Examples .....	Pages 42 through 47
Vending .....	Page 42
Coin/Currency .....	Pages 43 and 44
Sold-Out .....	Page 45
Select Panel/Display.....	Pages 46 and 47
Refrigeration Parts & Functions .....	Pages 48 through 52
Refrigeration Cycle.....	Page 53
Refrigeration Trouble Shooting.....	Pages 54 through 60
Product Hot - Compressor will not run.....	Page 54
Product Hot - Compressor starts but will not keep running .....	Page 55
Product Hot - Miscellaneous.....	Page 56
Product Cold But Not Cold Enough - Compressor runs but won't cool product .....	Page 57
Product Too Cold or Frozen - Compressor runs too long or continuously .....	Page 58
Noisy Refrigeration Unit.....	Page 59
Excessive Condensate.....	Page 60
Exclusive Parts List.....	Pages 61 through 66
Small Parts .....	Page 61
Wiring Harnesses.....	Pages 62 and 63
Select Panel Assemblies .....	Page 64
Main Door Assemblies .....	Page 65 and 66
Glossary .....	Page 67
Electrical Schematics .....	Pages A1 through A14

## WILLISTON, SC

Phone: (800) 688-9090

Phone: (803) 266-5000

FAX: (803) 266-5150

# **GENERAL INFORMATION**

## **VENDER SAFETY PRECAUTIONS**

**Please read this manual in its entirety. This service information is intended to be used by a qualified service technician, who is familiar with proper and safe procedures to be followed when repairing, replacing or adjusting any Dixie-Narco vender components. All repairs should be performed by a qualified service technician who is equipped with the proper tools and replacement components, using genuine Dixie-Narco factory parts.**

**Repairs and/or servicing attempted by uninformed persons can result in hazards developing due to improper assembly or adjustments while performing such repairs. Persons not having the proper background may subject themselves to the risk of injury or electrical shock which can be serious or even fatal.**

# MODELS AND DETAILS

## DNCB 168

Height: 56 11/16" (1439mm)  
Width: 28 5/16" (719mm)  
Depth: 30 1/2" (775mm)  
Wt: 464 lbs  
Can Capacity:  
330 ml or 12 oz.: 168

## DNCB 180

Height: 56 11/16" (1439mm)  
Width: 28 5/16" (719mm)  
Depth: 30 1/2" (775mm)  
Wt: 464 lbs  
Can Capacity:  
330 ml or 12 oz.: 180

## DNCB 276

Height: 72" (1829mm)  
Width: 28 5/16" (719mm)  
Depth: 30 1/2" (775mm)  
Wt: 574 lbs  
Can Capacity:  
330 ml or 12 oz.: 276

## DNCB 300

Height: 72" (1829mm)  
Width: 28 5/16" (719mm)  
Depth: 30 1/2" (775mm)  
Wt: 574 lbs  
Can Capacity:  
330 ml or 12 oz.: 300

## DNCB 348

Height: 72" (1829mm)  
Width: 37 1/16" (941mm)  
Depth: 30 1/2" (775mm)  
Wt: 728 lbs  
Can Capacity:  
330 ml or 12 oz.: 348

## DNCB 360

Height: 72" (1829mm)  
Width: 37 1/16" (941mm)  
Depth: 30 1/2" (775mm)  
Wt: 670 lbs  
Can Capacity:  
330 ml or 12 oz.: 360

## DNCB 368

Height: 72" (1829mm)  
Width: 37 1/16" (941mm)  
Depth: 30 1/2" (775mm)  
Wt: 690 lbs  
Can Capacity:  
330 ml or 12 oz.: 368

## DNCB 414

Height: 79 1/2" (2019mm)  
Width: 37 1/16" (941mm)  
Depth: 30 1/2" (775mm)  
Wt: 790 lbs  
Can Capacity:  
330 ml or 12 oz.: 414

## DNCB 440

Height: 79 1/2" (2019mm)  
Width: 37 1/16" (941mm)  
Depth: 30 1/2" (775mm)  
Wt: 748 lbs  
Can Capacity:  
330 ml or 12 oz.: 440

## DNCB 501

Height: 72" (1829mm)  
Width: 37 1/16" (941mm)  
Depth: 32" (813mm)  
Wt: 758 lbs  
Can Capacity:  
330 ml or 12 oz.: 501

## DNCB 600

Height: 79 1/2" (2019mm)  
Width: 37 1/16" (941mm)  
Depth: 32" (813mm)  
Wt: 840 lbs  
Can Capacity:  
330 ml or 12 oz.: 600



## PRODUCT IDENTIFICATION

The age of Dixie-Narco products is determined by the date code incorporated in the serial number.

The vender serial number takes the form xxxx-yyyzz. The first 4 digits (xxxx) identify the specific vender. The next 4 digits (yyyy) identify the manufacturing run that the vender was built in. The last two alpha characters (zz) identify the quarter and the year the vender was built. The first alpha character identifies the quarter:

- A = 1st quarter
- B = 2nd quarter
- C = 3rd quarter
- D = 4th quarter

The second alpha-character identifies the year:

- R = 1993
- S = 1994
- T = 1995
- U = 1996
- V = 1997
- W = 1998
- X = 1999
- Y = 2000
- Z = 2001

# **SII CAN & BOTTLE VENDER**

## **INSTALLATION & SET-UP**

The Dixie-Narco SII can and bottle vender is designed utilizing the latest technology featuring a highly sophisticated, micro-computer based control system. The SII Electronic Vender is designed to meet the growing need for accountability, multi-pricing, programmability, and system diagnostics in can vending equipment. Along with these functions, DEX/UCS-communications to a hand-held computer is available to provide the ability to measure each vending location for product performance, vender performance, and accessing accounting data. This data can be used to maximize the efficiency of routes for servicing venders. DEX communications also provides the bottler security for the integrity of the "cash in" versus the "product sold". The vender design provides the flexibility required for the changing beverage industry as well as dependable performance for many years. This manual is prepared to assist the proper installation and set-up of the vender. Please read this manual carefully and become familiar with the SII Vender before placing the vender on location.

### **Receiving Inspection**

Upon receipt, inspect the vender for shipping damage. If there is any damage, have the driver note the damage on the Bill of Lading and notify Dixie-Narco. Although I.C.C. regulations require that the consignee originate shipping damage claims, Dixie-Narco will gladly help if you must file a claim.

### **Unpacking The Vender**

Remove the stretch wrap and top covers from the vender. If flavor cards were shipped with the vender, they will be in an envelope affixed to the back of a vender in the shipment.

**NOTE: DO NOT STORE THE VENDER OUTDOORS WITH STRETCH WRAP ON. THIS COULD CAUSE THE STRETCH WRAP TO BOND TO THE VENDER'S SURFACE, WHICH COULD DAMAGE THE FINISH.**

Remove the shipping boards from the bottom of the vender. The shipping boards are attached by the leveling legs. Remove the shipping boards by **unscrewing** the leveling legs. This will avoid unnecessary damage to the leveling legs or the base. A 1½" "socket-type" wrench should be used on the bottom of the leveling legs. Be sure to replace the legs after removing the shipping boards.

To open the vender, locate the door lock keys which are secured inside the coin return cup. After unlocking the door, rotate the "T"-handle counter-clockwise until the door can be opened. Once inside, check the coin box on the door for any additional parts, pricing labels, or information concerning factory equipped accessories. Check the "T"-handle for proper alignment and locking functions. Check the lamps for proper installation.



**WARNING: INSURE THAT POWER IS DISCONNECTED FROM THE VENDER OR THAT THE POWER INTERRUPT SWITCH (IF PROVIDED) IS NOT DEFEATED BEFORE INSPECTING OR REPLACING THE LAMPS. FAILURE TO COMPLY WITH THESE INSTRUCTIONS MAY SUBJECT THE USER TO THE RISK OF INJURY OR ELECTRICAL SHOCK WHICH CAN BE SERIOUS OR FATAL.**

## Electric Power Needed

Refer to the vender serial number plate to determine the proper voltage and frequency the machine requires (domestically this requirement is 115 volt, 60 hertz). Domestic venders will operate at +/- 10% of the specified voltage. For domestic models this is between 103 volts and 127 volts. Single phase, alternating current is required. The vender must be plugged in its own properly rated circuit with its own circuit protection (fuse/circuit breaker).

**DO NOT USE AN EXTENSION CORD.**

## Ground The Vender

The vender is equipped with a three wire power supply cord and **MUST** be plugged into a properly grounded outlet.

**DO NOT REMOVE THE GROUND PIN OR IN ANY WAY BYPASS THE GROUNDING OF THE VENDER.** If the outlet will not accept the power cord plug, contact an electrician to install a proper AC outlet.



**WARNING:** Failure to comply with these instructions may subject the user to the risk of injury or electrical shock which can be serious or fatal.

## COIN CHANGERS AND OTHER ACCESSORIES

The SII vender must have a coin changer installed and can have a bill acceptor installed. If the coin changer and other accessories are not factory installed refer to the instructions received from the manufacturer of the coin changer and other accessories for proper set-up and installation.

The SII vender will support the following coin changers:

Micro-Mech/Controller	110 V (12 pin) Changers (Domestic)
Mars TRC 6000	
Coinco 9300L	
Maka USPX001	

Micro-Mech Controller	24 V (15 pin) Changers (Domestic)
Mars TRC 6010 XV	
Coinco 9302LF	

**CAUTION: DO NOT USE 24 V (12 PIN) CHANGERS. USE OF 24 V (12 PIN) CHANGERS WILL CAUSE DAMAGE TO ELECTRONICS PACKAGE AND CHANGER.**

Multi-Drop Coin Mech (Domestic)
Coinco 9302GX
Mars TRC6510

L+ Coin Mech (International)

Executive Coin Mech (International)

BDV Coin Mech (International)



## BILL ACCEPTORS

If a bill acceptor is not factory installed, a bill acceptor interface harness must be ordered from Dixie-Narco. See the chart below:

### BILL VALIDATOR INTERFACES

<b>Dixie-Narco USA (Low Level Interface)</b>	need harness 804,906,640.31 or extended harness 804,908,120.01 from Dixie-Narco
<b>Mars VFM-1 (Low Level Interface)</b>	need harness 804,906,640.31 or extended harness 804,908,120.01 from Dixie-Narco
<b>Mars VFM-3 (Low Level Interface)</b>	same as VFM-1
<b>Coinco BA-30 (MDB)</b>	need 407420 harness from Coinco (DN #804,909,040.01)
<b>Coinco BA-30 (High Level Interface)</b>	need 407518 harness from Coinco (DN #804,909,050.01) for Pepsi/Generic or 407519 harness from Coinco for Coke & 804,907,710.01 from Dixie-Narco
<b>CBA-2 (Coinco/Rowe) (High Level Interface)</b>	need 804,907,790.01 harness from Dixie-Narco
<b>MAKA NB10L-200 (High Level Interface)</b>	need 804,907,710.01 harness from Dixie-Narco

Important: Mounting hardware is not listed

Note: Bill acceptors will be inhibited anytime the door interlock switch is in the center position (service mode enable) even if service mode time out has occurred restoring the vender to normal operation.

## OTHER ACCESSORIES

The SII Vender is capable of interfacing to Debit Card and Data Recording systems. At this time only a few such accessories have been tested by Dixie-Narco. If such accessories are to be used check with either Dixie-Narco or the accessory manufacturer about physical and electrical compatibility before attempting to interface such accessories to the SII Vender. The SII supports any debit card/data recording manufacturer's systems that meet NAMA II protocol.

## INSTALLING A COIN CHANGER

Hang the coin changer on its mounting plate and secure it by tightening the three securing screws. Plug the coin changer into the 15 pin Jones socket or the 6 pin socket for MDB changers, in the vender. The 15 pin Jones socket is designed to accept the 12 pin plug used on 110 V controller style coin changers.

**CAUTION:** The coin changer must be plugged in with the power removed from the door or the coin changer may not power on properly. If a bill acceptor is being used, the bill acceptor must be interfaced to the SII control board.

After restoring power, manually load the coin changer coin tubes with at least 10 coins each. Following the program instructions for the SII Vender, program each selection for its own vend price. A price of \$0.00 is free vend. After the pricing is set return the vender to its operate mode either by closing the door or pulling the door closed switch out. "Prime" the coin changer by making a correct change transaction.

**Note:** If using a Mars TRC-6000 coin changer function switch #4 in the coin changer, must be set in the off position (down).

## **Placing The Vender On Location**

**CAUTION: DO NOT TRANSPORT THE VENDER TO OR FROM THE LOCATION WHEN IT IS LOADED WITH PRODUCT; DAMAGE TO THE VENDER MAY RESULT.**

**The vender must be located on a solid, flat, and level surface.**

The vender must be positioned close enough to an electrical outlet that an extension cord is not required. If securing the vender to the floor or wall is required, call the Dixie-Narco Factory Service Department for suggestions.

### **Level The Vender**

Level the vender. When the vender is level, the door can be opened to any position and it will not move by itself.

Open the door to several different positions before deciding that the vender is level. Make sure that all of the leveling legs are in contact with the floor. If you cannot level the vender, select another location. Do not place any objects under the machine.

**DANGER: THE VENDER MUST BE PROPERLY LOCATED AND LEVELED TO MINIMIZE THE RISK OF INJURY OR DEATH FROM TIPPING IN THE EVENT OF MISUSE OR VANDALISM.**

### **Space The Vender**

Do not block the rear of the vender. Keep the vender 4 inches (10 cm) from the wall to insure adequate air flow to the condenser and compressor. At the front of the vender, make sure that nothing obstructs the air intake at the bottom of the main door. At the rear of the vender, make sure that nothing obstructs the air exhaust at the bottom of the cabinet.

### **Installing Flavor Cards**

The flavor cards may be inserted one of two ways: 1) in the selection buttons, or 2) in the flavor card carrier.

- 1.) Swing the coin changer mounting plate away from the outer door exposing the back of the select buttons. The flavor cards are inserted in the back of the selection buttons from either side. Ensure the flavor cards are placed in the select buttons that correspond to the column in which the product is loaded.
  
- 2.) Swing the coin changer mounting plate away from the outer door, exposing the back of the select panel. Remove the flavor card carrier. Ensure the flavor cards are placed in the select button flavor card carrier position that corresponds to the column in which the product is loaded. Install the flavor card carrier back into position.

# Loading Instructions

## Product Vending

Dixie-Narco venders are shipped ready to vend 12 oz. cans unless another package was specified at the time the vender was ordered. If packages other than 12 oz. cans are to be vended, contact the Dixie-Narco Factory Service Department for the proper instructions.

The closure strip and the discharge member are set for the maximum security when vending cans. To vend bottles, refer to the illustration below.

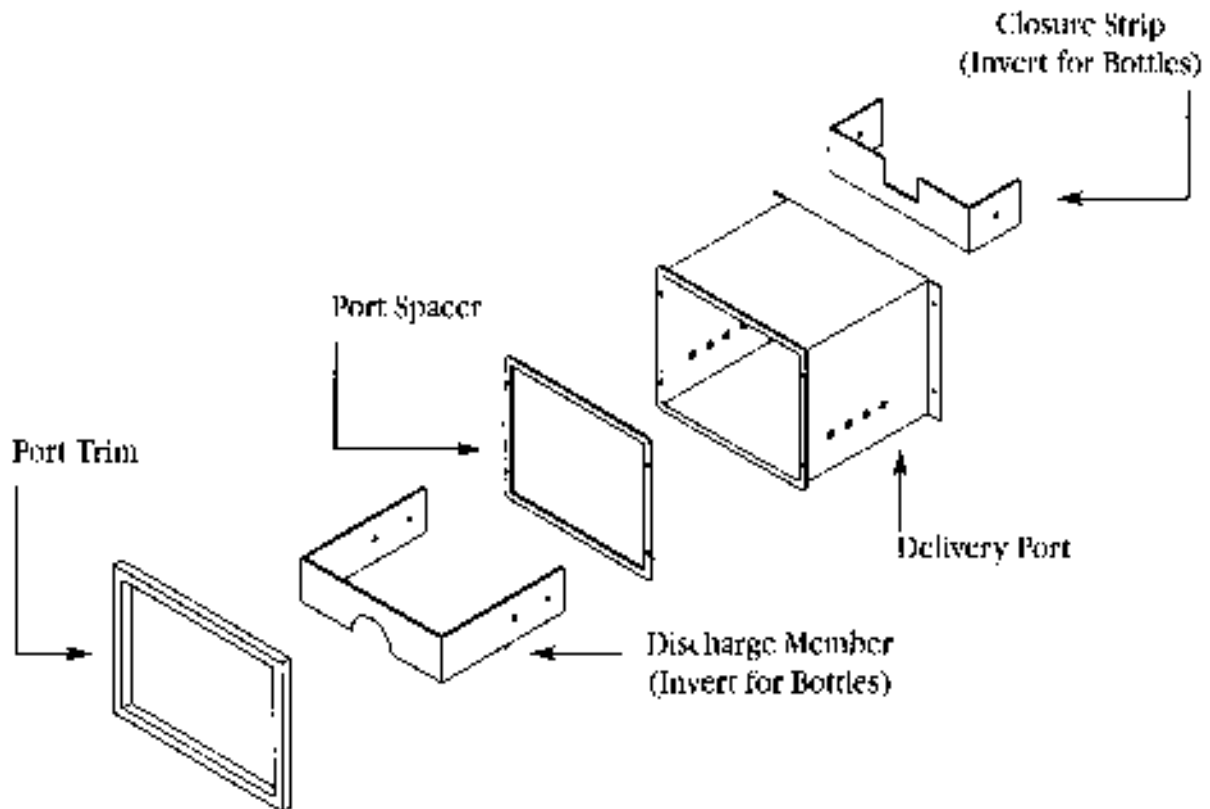

# HARDWARE CONFIGURATION

The hardware configuration for the SII Controller consists of a main control board and a display board. The select panel consists of low voltage switches. The sold-out indicators utilize LED technology. The select switches and sold-out indicators interface directly to the main controller.

The motors used on the stack are 115 VAC type. The vend switches and sold-out switches are low voltage type. There is only one vend switch per motor and one sold-out switch per column. The motors, vend switches, and sold-out switches interface directly to the main controller board. Each motor is independently controlled to provide the maximum flexibility for space to sales. The Main Controller supports up to 10 motors and 10 selections.

The Main Controller consists of two boards stacked on top of each other. The top board consists of all the intelligence, memory, switch interfaces, and stack interface (motors, vend switches, and sold-out switches). The bottom board has the peripheral interfaces which include coin changers, dollar bill validators, Dex interface and debit systems.

The Dex interface supports both an internal connection as well as an external connection. The interconnect is a ¼" phono jack as specified by the specification approved by NAMA. The initial hand-held devices supported are Norand, Mar's MEQ, Fujitsu, and lap top PCs. All electrical specifications, protocols, and baud rates are identified in the specification.

A door switch is included to determine door accesses. A system set-up/ audit switch is located on the main controller board to access accounting data and programming features through the front select panel. A system diagnostics switch will be located on the main controller board to access diagnostic features through the front select panel.

A real time clock (RTC) with battery backed memory is provided so that memory can be maintained during power failures. The battery life expectancy is 5 years shelf and 10 year operational. The real time clock is displayed in military time (24 hour clock). It is used for time stamping door closures, power outages, limited access, and selective discount pricing.

The intelligence of the Main Controller is an Intel 80C32 microprocessor. A minimum of 64k of EPROM and 8k of RAM (battery backed) is provided.

The Display Board consists of four 7-segment LEDs to provide alpha-numeric characters. Also, the exact change indicator consists of an LED.

# FEATURES

The following is a description of all the features of the SII.

## **- Dex Compatible Hand-held Interface -**

The vending industry (NAMA) has established an audit data protocol which is defined by Dex (Direct Exchange Of Data) and UCS (Uniform Communications Standards). This interface is a direct connect as defined by the specification. The SII has provisions for an internal and external connection. The external connection provides a limited amount of information.

The internal connection provides the full capability of Dex/UCS. These capabilities include full audit of interval and historical data, system programming, diagnostics, and limited access.

## **- 10 Column Stack Compatible -**

The SII Controller is capable of driving up to 10 stack motors independently. The motors are 110 VAC. The vend switches and empty detection switches are low voltage, gold cross-point switches. The interface for the cam position and empty detection is located on the controller board.

## **- Low Voltage Select Panel -**

The select panel consists of gold cross-point switches and bright-red LEDs for sold-out indicators. The interface circuitry is located on the controller board. The controller board supports up to 10 selections and 10 sold-out indicators.

## **- Programmable Space To Sales -**

Programmable space to sales is a feature which allows select buttons to be ganged (operated simultaneously as a group). Columns are dispensed evenly when more than one select button contains the same product.

## **- Select Panel Controller Programming -**

or

## **- Hand-held Controller Programming -**

The SII vender has the capability to be programmed through the select panel. The SII vender can also be programmed through the Dex port with the same hand-held used to access the accounting data.

## **- LED Display (Light Emitting Diodes) -**

### **Optional LCD Display (Liquid Crystal Display)**

The display consists of 4 characters utilizing 7 segment LEDs for each character to provide a true alphanumeric display. The display is implemented on it's own printed circuit board. The display board interfaces to the main controller via the "Dixie" bus.

International opportunities may require different language sets which may not be capable of being displayed on the LED display. Other technologies may be more appropriate such as LCD displays. With the "Dixie" bus interface, different display modules can be adapted without changing any other part of the system.

**- Sold Out Light/Selection -**

Each selection is supported by a sold-out indicator. Bright-red LEDs are used. LEDs are used to eliminate hi-voltage from the select panel.

**- Price Display -**

If all selections are set at the same vend price, in primary pricing and secondary pricing, the vend price is shown on the display. If multi-pricing is used, pressing any select button shows the vend price of that particular selection on the display.

**- Single Price or Multi-Price via Select Panel or Hand-held -**

Prices for each selection can be programmed either through the front select panel or through the Dex hand-held device. For single price configuration, each selection has to be programmed for the same price since single-price coin changers are not supported. To set all selections for the same price: 1) Enter "S-P" mode in set-up/audit mode, 2) set desired vend price on select button #1, 3) simultaneously press and hold select buttons 3 and 4 for ten seconds, this will change the vend price of all selections to the price programmed to select button #1.

**- Accounting Data Provided -**

The accounting features can be accessed through the front select panel. These include **(Hd)** historical data, which is not resettable and **(Rd)** resettable data which is resettable.

**(Hd)** Historical Data includes:

The total cash collected by the vender, the total number of vends by the vender and the number of vends by each selection.

**(Rd)** Resettable Data includes:

The total cash collected since the last counter reset, the total number of vends since the last counter reset, the number of vends by each selection since the last counter reset and allows the resettable data to be zeroed.

The types of data that can be retrieved via the dex interface to a hand-held device is addressed in the SII Audit Features section on pages 15 and 16.

**- Limited Access on Selection (Time, Days, Price) -**

The limited access feature allows each selection to be inhibited with respect to time and selected days of the week. Also, prices of selections can be altered (Happy Hour) with respect to time and selected days of the week.

## SII AUDIT FEATURES

The SII provides two methods of accessing audit data. A limited amount of audit information is available in the system set-up/audit menu. More extensive audit information is accessible electronically.

### SYSTEM SET-UP/AUDIT MENU

Six types of audit data are available in the system set-up/audit menu: Historical Data (**Hd**) which includes total cash collected, total vends and the total number of vends by each selection; Resettable Data (**Rd**) which includes total cash collected since last counter reset, total vends since last counter reset and total number of vends by each selection since last counter reset.

The audit data is accessed by pressing the system set-up/audit switch. The display will show "**Hd**". Pressing select button "1" displays the total cash collected by the vender. Pressing select button "2" displays the total vends by the vender. Pressing select button "3" displays the total number of vends by each selection. Each selection is automatically scrolled across the display. Pressing select button "1" and "2" simultaneously will move to the next function. The display will show "**Rd**". Pressing select button "1" displays the total cash collected since the last counter reset. Pressing select button "2" displays the total vends since the last counter reset. Pressing select button "3" displays the total number of vends by each selection since the last counter reset.

## ELECTRONIC ACCESS

A much more extensive amount of audit information is accessible electronically. It is retrieved with a portable data collection device and typically loaded in a computer at a central location. The data can then be tracked with a data base, for preparing route stocking lists, tracking cash flow, doing inventory control and other tasks. Data collection devices are available from several sources including: Norand, Fujitsu, Panasonic, Telxon, Verifone and Mars. Dixie-Narco currently collects data with a PC program running on a portable notebook computer.

The SII uses the DEX/UCS protocol as the method of exchanging data with the portable data collection device. DEX/UCS was formally adopted as the standard method of collecting audit data for the vending industry by the National Automatic Merchandising Association (NAMA) in April of 1991. DEX/UCS has been used in related industries since 1989. It was developed by the Arthur D. Little Company and is administered and maintained by the Uniform Code Council (UCC). The NAMA Vending Electronics Standardization Committee developed and published a comprehensive set of data records relevant to the vending industry. The SII reports the portion of these related to this specific machine design. The current list of records and their usage by the SII follows.

DEX stands for Direct EXchange of data, which means there is a hard-wired connection between the two systems exchanging data. This is done by inserting a ¼ inch phone plug on the portable data collection device in a jack mounted on the SII. Inserting the plug automatically initiates the exchange of data, which takes several seconds. No other machine functions are available while the exchange is taking place. The operator is told that the exchange is taking place by the display of the message "DEX IN PROGRESS". Most of the data records are reported in both an interval and historical format. The historical values represent a total of the values since the machine shipped from the factory. The interval values are the data collected since the last time it was collected electronically.

The following types of audit data are accessible electronically:

- Machine Identity Information
- Date and Time of Interrogation
- Cash Sales Summary
- Cash Input and Output Summary
- Product Sales Information
- Machine Configuration
- Events:
  - Door Openings
  - Interrogations
  - Programmable Access Limits
  - Time of Day Discounts
  - Sold-Out Selection Information

In addition to retrieving audit data, every machine configuration parameter that can be programmed in the service menu can be programmed electronically via the DEX port.

The following types of data can be configured electronically:

Machine Identity	Space-to-Sales
Date and Time	Limited Access Control Parameters
Time of Day Discounts Control Parameters	Price and Product Information

\*Escrow Mode

\* Escrow mode cannot be transferred with the Norand Device.



## PROGRAMMING THE SII VENDER

To program the SII vender, it is necessary to enter the System Set-Up/Audit mode. Open the inner door and press the System Set-Up/Audit Switch on the control board. The display will read "Hd". If the display reads ".05", the door switch did not go to its center position or the switch is defective.

Note: The door switch has three positions. Fully in and fully out puts the vender in its normal mode. When the switch is in its center position the System Set-Up/Audit or System Diagnostics mode may be entered.

There is a time-out for the Service Modes. If no accounting or set-up functions are used for two minutes, the vender will return to its normal mode. After time out, the System Set-Up/Audit or System Diagnostics switch on the control board has to be pressed to re-enter the modes.

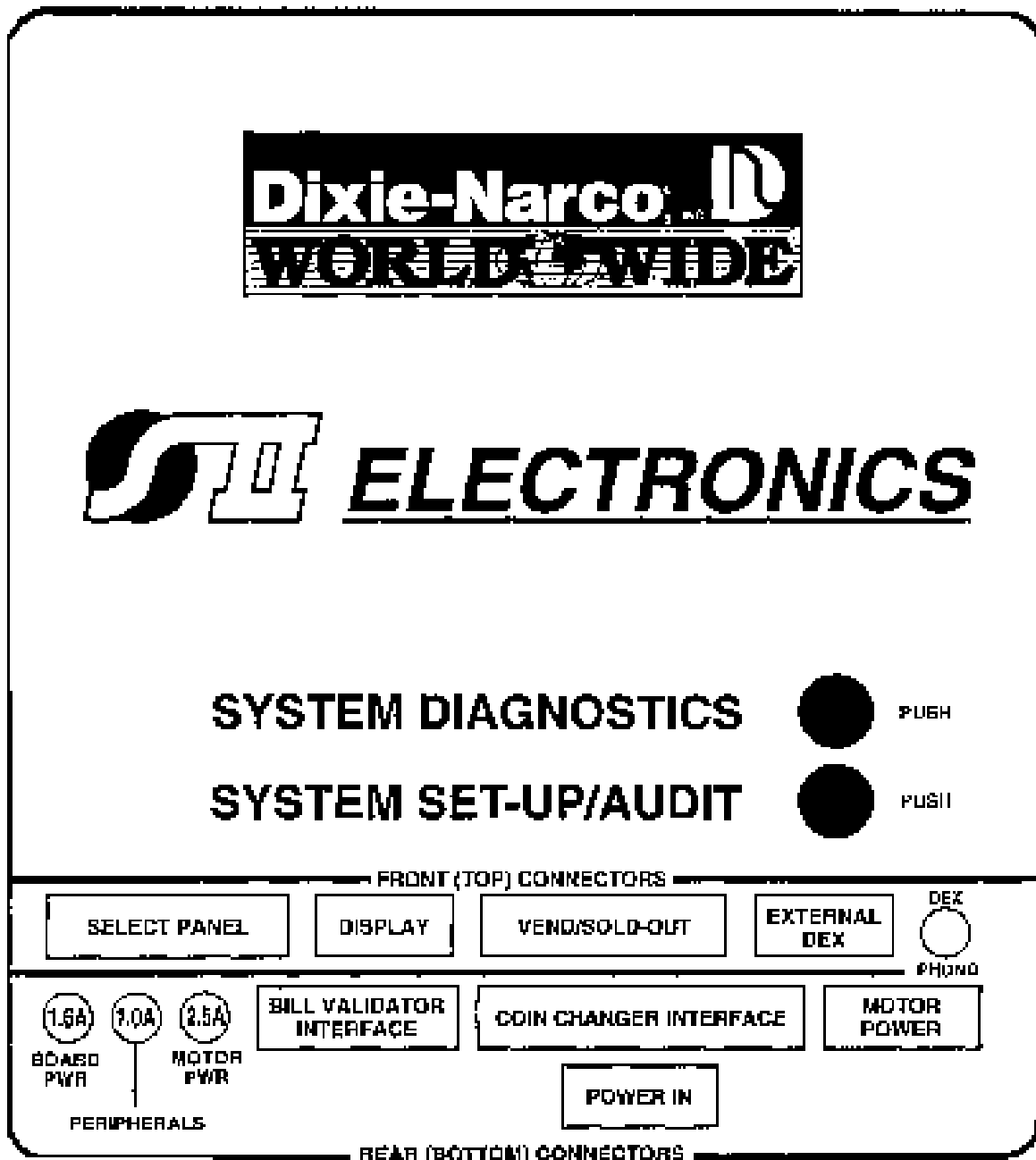

# SII CONTROLLER PROGRAMMING

The controller has three modes of operation:

**NORMAL, SYSTEM SET-UP/AUDIT and SYSTEM DIAGNOSTICS**

## **NORMAL MODE:**

In normal mode, the display will show a solid decimal point. A flashing decimal point indicates a recognized failure. When money is inserted, the display indicates the total amount of the deposit. The select buttons are used to select the product.

## **SYSTEM SET-UP/AUDIT MODE:**

System set-up/audit mode is entered when the vender inner door is open and the system set-up/audit switch is pressed. The controller display shows "Hd" at this time. The message indicates what function the controller is prepared to perform. When the top two select buttons (1 & 2) are pushed simultaneously, the controller goes to the next function and displays a message from the list below.

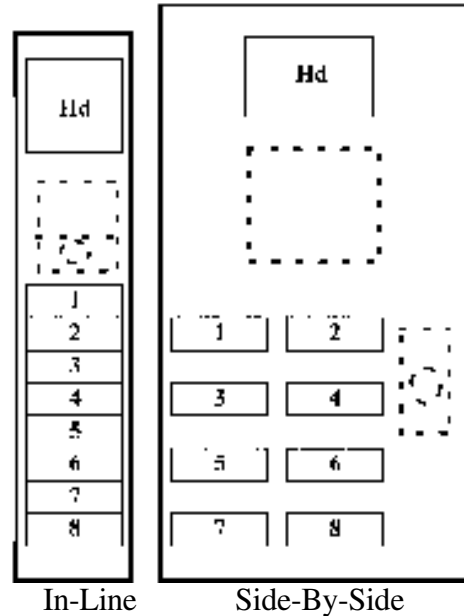

## **SYSTEM DIAGNOSTICS MODE:**

System diagnostics mode is entered when the vender inner door is open and the system diagnostics switch is pressed. The controller display shows "SE-" at this time. The message indicates what functions the controller is prepared to perform. If there is a problem, the controller display will show a message. "SS-#" is a select switch problem, "JC-#" is a jammed column problem, and "Pbf" is a power board failure (replace board). When the top two select buttons (1 & 2) are pushed simultaneously, the controller goes to the next function and displays a message from the system diagnostics list.

## **EXIT SYSTEM SET-UP/AUDIT OR DIAGNOSTIC MODE:**

Closing the inner door or a two minute inactivity time-out will exit the system set-up/audit or diagnostics mode.

## **FRONT PANEL PROGRAMMING SYSTEM SET-UP/AUDIT MENU**

### **Hd - Historical Data:**

This section shows the user the vender accounting over the life of the vender. Use the following select buttons to view the total sales in dollars, total number of vends and the total number of vends for each selection.

- Press Select Button 1: Shows the historical total cash sales for the life of the vender.
- Press Select Button 2: Shows the historical total number of vends.
- Press Select Button 3: Shows the historical number of vends by selection. Each selection automatically scrolls across the display.
- Press Select Buttons 1 & 2 simultaneously to move to the next item on the menu.

## **Rd - Resettable Data:**

This section shows the user the vender accounting data since the time of the last counter reset.

- Press Select Button 1: Shows the total cash collected since the last counter reset.
  - Press Select Button 2: Shows the total number of vends since the last counter reset.
  - Press Select Button 3: Shows the total number of vends by selection since the last counter reset. Each selection automatically scrolls across the display.
  - Press & Hold Select Button 4: This button zeros the resettable data described above. Hold button "4" for 5 seconds and "COUnTErS rESEt" will be displayed. At this time, all resettable data will return to "0".
- Press select buttons 1 & 2 simultaneously to move to the next item on the menu.

## **C-d - COIN DUMP/COIN FILL MODE:**

### **C-d - COIN DUMP:**

This section is used to dump coins from the coin mechanism while in "C-d" mode.

- Press & Hold Select Button 1: Dump Nickels.
- Press & Hold Select Button 2: Dump Dimes
- Press & Hold Select Button 3: Dump Quarters.

### **C-d - COIN FILL MODE:**

This section is used to count coins loaded in the top (separator) of the coin mech. Insert coins in the top (separator) of the coin mech. The total value of the coins will be displayed and will be counted in the DEX audit data, so the SII controller knows exactly how much change is in the coin mech.

Press select buttons 1 & 2 simultaneously to move to the next item on the menu.

## **ESC - ESCROW:**

This section supports five escrow options. To show the current escrow condition, push any select button. To change the escrow condition press and hold the appropriate select button.

### **Select Button 1 "Pr" - Escrow to Price**

The #1 sold out lamp will illuminate. The escrow condition is "escrow to price". All dollar bills will be stacked. No cancel sale is allowed once minimum vend price is met or exceeded.

### **Select Button 2 "E-S4" - Escrow to Select 4**

The #2 sold out lamp will illuminate. The escrow condition is "escrow to select" with all dollar bills being stacked. Cancel sale will return the deposit from the coin changer (i.e. 4 quarters).

### **Select Button 3 "E-S1" - Escrow to Select 1**

The #3 sold out lamp will illuminate. The escrow condition is "escrow to select" with the last dollar bill that meets or exceeds maximum vend price being escrowed in the validator. Cancel sale will return the held dollar bill and any amount over \$1 will be returned from the coin changer.

### **Select Button 4 "CR" - Change Rules (for use with foreign L-Plus coin mechs only)**

*Some countries have coin mechs that do not use all three coin tubes. This would not allow the SII to come out of exact change mode. To accommodate this, the Change Rules section allows the SII to be programmed to use the tubes necessary for the SII to not be in an exact change mode.*

*To enter "CR", press and hold #4 select button for 15 seconds.*



### **COIn - COIN MECH SELECTION:**

This function is used to display and change the coin mechanism selected. To display the current coin mechanism selected, press a select button. To change the coin mechanism selected, press and hold the appropriate button until the display shows the new mechanism selected. Note: The sold out lamp that corresponds with the select button will also illuminate.

Select Button 1:       Micro-Mech/Controller                    nn  
Includes: 110v (12 pin) Changers listed:  
                  Mars TRC 6000  
                  Coinco 9300L  
                  MAKA USPX001

Includes: 24v (15 pin) Changers listed:  
                  Mars TRC 6010XV  
                  Coinco 9302LF

**CAUTION: DO NOT USE 24V (12 Pin) CHANGERS. USE OF 24V (12 Pin) CHANGER WILL CAUSE DAMAGE TO ELECTRONICS PACKAGE AND CHANGER.**

Select Button 2:       L + Coin Mech                                Lt  
Select Button 3:       Executive Coin Mech                            EC  
Select Button 4:       BDV Coin Mech                                bdu  
Select Button 5:       Multi Drop Coin Mech                            ndb  
Includes:            Coinco 9302GX  
                  Mars TRC 6510

Press select buttons 1 & 2 simultaneously to move to the next item on menu.

### **SOI - Sold-Out Indication:**

This function indicates sold-out by either discrete sold-out LEDs or by "sold-out" message on the display. The sold-out message appears when the select button of an empty column is pressed. To display the current sold out indication, press any select button.

To Change Sold-Out Indication:

Press & Hold Select Button 1:       "DIS" will be displayed and the #1 sold out lamp will illuminate. The sold-out indication is the discrete sold-out lights.

Press & Hold Select Button 2:       "nES" will be displayed. The sold-out indication is the displayed "Sold-out" message when a select button is pushed.

Press select buttons 1 & 2 simultaneously to move to the next item on menu.

### **S-P - SET PRICE:**

This function is used to set the price of each selection. When a select button is pressed, the price for that selection will be displayed. If the button is held in, the price will increment or decrement. To change from increment to decrement, release the select button and press it again.

Note: The SII's multi-pricing capability allows you to set all selections to any price in the range of \$0.00 to \$12.50.

Press select buttons 1 & 2 simultaneously to move to the next item on menu.

**StS - SPACE TO SALES:**

To view the space to sales condition, press any select button to display the current selections assigned to that select button. To change space to sales condition:

**To Add Selection:**

Depress Set-Up Switch, "Add" will be displayed. Note: Pressing the set-up switch will toggle between add and delete. Press and hold any select button, whichever select button you are holding is the select button the additional selection will be assigned. While holding the select button, the display will read "Add #" and the selection will increment from 1 to 10. Release select button when the desired selection # to be added is displayed. A message will scroll across the display telling you what selection will be assigned to the button you were holding. Depress Set-Up switch to complete space to sales decision and re-enter service mode.

**To Remove Selection:**

Depress Set-Up Switch twice, "dEL" will be displayed. Note: Pressing the set-up switch will toggle between add and delete. Press and hold any select button, the select button you are holding is the select button from which the additional selection will be removed. While holding select button, the display will read "dEL #" and the selections will increment from 1 to 10. Release select button when the desired selection # to be removed is displayed. A message will scroll across the display telling you what selection will be deleted from the button you were holding. Depress Set-Up Switch to complete space to sales decision and re-enter service mode.

**NOTE:** Only one space to sales change may be made at a time. The set-up/audit switch must be pressed before and after each change.

Press select buttons 1 & 2 simultaneously to move to the next item on menu.

**tInE - TIME:**

To display time, press and let go of any select button. Time will be displayed in military time (24 hour clock). To change time, press and hold select button **1 or 2**, the time will increment or decrement. To change from increment to decrement, release the select button and press it again.

Press Select button 1 to set hours.

Press Select button 2 to set minutes.

Press Select buttons 1 & 2 simultaneously to move to the next item on menu.

**dAtE - DATE:**

To view date, press and let go of select button **1 or 2** to display month and day, press and let go of button **3** to display day of week, press and let go of button **4** to display year.

To change date, press and hold a select button to set the following:

Press Select Button 1:		Month			
Press Select Button 2:		Day			
Press Select Button 3:		Day Of Week			
	Sunday	1	Wednesday	4	Saturday 7
	Monday	2	Thursday	5	
	Tuesday	3	Friday	6	

Press Select Button 4: Year

Press select buttons 1 & 2 simultaneously to move to the next item on menu.

**LAOS - LIMITED ACCESS ON SELECTION:**

This function is used to set selection(s) which will be limited during certain periods of the day. To view the limited access on selection condition, press and let go of any select button. A message will appear on the display telling you if limited access is disabled or if any selections are enabled. To change limited access on any selection, press and hold the desired select button until the message displayed is the desired limited access condition for that selection.

Enabled #s - Selection(s) displayed are on limited access.

Disabled - All selections are not on limited access.

Press select buttons 1 & 2 simultaneously to move to the next item on menu.

**LAOd - LIMITED ACCESS ON DAYS:**

This function is used to set the days of the week for limited access. To view the limited access on days condition, press and let go of any select button. A message will appear on the display telling you if limited access is disabled or enabled for any days.

Sunday	1	Tuesday	3	Thursday	5	Saturday	7
Monday	2	Wednesday	4	Friday	6		

To change limited access on days:

To Add Days:

Press set-up switch, "Add" will appear on display. Press and hold any select button to scroll through days. Release select button at desired day to enable limited access. Press set-up switch to complete limited access on days decision.

To Remove Days:

Press set-up switch, "Add" will appear on display. Press set-up switch again, "dEL" will appear on display. Press and hold any select button to scroll through days. Release select button at desired day to disable limited access on that day. Press set-up switch to complete limited access on days decision. This must be done for each day to be removed.

NOTE: Only one limited access on days may be made at a time. The set-up/audit switch must be pressed before and after each change.

Press select buttons 1 & 2 simultaneously to move to the next item on menu.

**PER1 PERIOD 1 FOR ENGAGING AND DISENGAGING LIMITED ACCESS:**

This function is used to set time to start and end limited access. To display PER1 start time, press and let go of select button **1 or 2**. To display PER1 end time, press and let go of select button **3 or 4**.

To Change:

PER1 Start Time:

To change start time, hold select button **1** to change hours, and select button **2** to change minutes. The time will increment or decrement. To change from increment to decrement, release the select button and press again.

PER1 End Time:

To change end time, hold select button **3** to change hours, and select button **4** to change minutes. The time will increment or decrement. To change from increment to decrement, release the select button and press again.

Note: Start time has to be less than end time. You must set an on and off time when using Per1.

Press select buttons 1 & 2 simultaneously to move to the next item on menu.

**PEr2-PERIOD 2 FOR ENGAGING AND DISENGAGING LIMITED ACCESS:**

Set time to start and end limited access the same as period 1.

Limited access can be enabled for two different periods in one day. Period 2 must be greater than period 1.

Press select buttons 1 & 2 simultaneously to move to the next item on menu.

**S-P2 PRICE - SECONDARY SET PRICE:**

This function is used to set a secondary price for each selection. When a select button is pressed, the price for that selection will be displayed. If the button is held in, the price will increment or decrement. To change from increment to decrement, release the select button and press it again.

Press select buttons 1 & 2 simultaneously to move to the next item on menu.

**Pr2P - PERIOD FOR ENGAGING AND DISENGAGING SECONDARY PRICES:**

This function is used to set time to start and end secondary prices. To display Pr2P start time, press and let go of select button **1 or 2**. To display Pr2P end time press and let go of select button **3 or 4**.

To Change:

Pr2P Start Time:

To change start time, hold select button **1** to change hours, and select button **2** to change minutes. The time will increment or decrement. To change from increment to decrement, release the select button and press again.

Pr2P End Time:

To change end time, hold select button **3** to change hours, and select button **4** to change minutes. The time will increment or decrement. To change from increment to decrement, release the select button and press again.

There is only one period in a day for enabling secondary pricing.

Note: Start time has to be less than end time. You must set an on and off time when using Pr2P.

Press select buttons 1 & 2 simultaneously to move to the next item on menu.

**Pr2d - SECONDARY PRICING ON DAYS**

This function is used to set the days of the week for secondary pricing. To view the Pr2d press and let go of any select button. A message will appear on the display telling you if Pr2d is disabled or if any days are enabled.

Sunday	1	Tuesday	3	Thursday	5	Saturday	7
Monday	2	Wednesday	4	Friday	6		

To change Pr2d:

To Add Days:

Press set-up switch, "Add" will appear on display. Press and hold any select button to scroll through days. Release select button at desired day to enable Pr2d. Press set-up switch to complete Pr2d decision.

To Remove Days:

Press set-up switch, "Add" will appear on display. Press set-up switch again, "dEL" will appear on display. Press and hold any select button to scroll through days. Release select button at desired day to disable Pr2d. Press set-up switch to complete Pr2d decision.

NOTE: Only one secondary pricing on days may be made at a time. The set-up/audit switch must be pressed before and after each change.

Press select buttons 1 & 2 simultaneously to move to the next item on menu.



## PrOn - PROMOTIONAL SALES

This function is used to initiate a promotional sale. To show the current promotional condition, press:

- Select Button 1: To show number of vends required to initiate promotion.
- Select Button 2: To show number of free beverages to be delivered after the number of required vends have occurred, as programmed, to initiate promotion.
- Select Button 3: To show the selections that are enabled for the promotion.

To change the promotional sales conditions, press:

- Select Button 1: "Un-0", where 0 is the number of vends required to initiate the promotional sale. To change the number of vends required, press and hold select button 1. The number of vends will increment to a maximum of 25 and then return to zero.

Note: If "Un-0", the promotion is disabled.

- Select Button 2: "Fr-0", where 0 is the number of free beverages delivered after the number of vends have occurred as programmed above. To change the number of free beverages, press and hold select button 2. The number of free beverages will increment to a maximum of 25 and then return to zero.

- Select Button 3: Display will show "disabled" or enabled # (s) where # shows the selections that are enabled for the promotion to occur. To add or delete selections:

- A) Press the system set-up/audit switch. The display will show "Add", indicating selections will be added. Press the system set-up/audit switch again and the display will show "dEL", indicating selections will be deleted.
- B) Press and hold any select button. The display will show "Add #" or "dEL #", where # is a select button number. While holding a select button, the # will increment to the maximum select button number and return to 1.
- C) Release the select button when the desired selection # to be added or deleted is displayed. A message will scroll across the display, telling you what selection will be added or deleted.
- D) Depress the system set-up/audit switch to complete the decision.

Note: Only one selection may be added or deleted at a time. The system set-up/audit must be pressed before and after each change.

Important: Promotional sales, when enabled, will be on at all times of the day.

Press select button 1 & 2 simultaneously to move to the next item on menu.

## **Lan6 - LANGUAGE**

This function is used to set the language that will be used for display messages. To display the current language selected, press any select button. To change the language selected, press and hold the appropriate select button until the display shows the new language selected. Note: The sold out lamp that corresponds with the select button will illuminate.

Select Button 1:	English	En6L
Select Button 2:	German	6erN
Select Button 3:	Spanish	SPn
Select Button 4:	French	Frn
Select Button 5:	Italian	ItA

Press select button 1 & 2 simultaneously to move to the next item on menu.

## **ECnt - ELECTRONIC COUNTER**

This function is used to show historical total vends, interval product counts that have occurred for prices being used, and interval product count for each selection from outside the vender.

To show the current count, hold the \* four keys programmed for five (5) seconds. The display will show historical total vends. To view other data, press:

Select Button 1:	Show historical total vends.
Select Button 2:	Show list of prices and interval product counts that have occurred for those prices.
Select Button 3:	Show interval product count for each selection.
Select Button 4:	Press and hold for 5 (five) seconds to reset interval data.

Note: There is a two (2) minute time-out that will return the vender to normal vending mode.

### **\* Electronic Counter Four (4) Key Programming**

To view current setting, press any select button. The display will show the four (4) select buttons chosen or "--". "----" means no code is programmed.

To change four (4) key program:

- A) Press system set-up/audit. Display will show "----", indicating the new code is ready to be entered.
- B) Press the four (4) select buttons that are desired to be in the code. As they are pressed, the display will change to show the four (4) select buttons chosen. Note: Four (4) separate buttons must be used or the pattern will not be saved.
- C) Press the system set-up/audit switch. The display will change back to "ECnt".

## SII SYSTEM DIAGNOSTICS MENU

If there is a problem, the controller display will show a message, when the system diagnostics switch is pressed. If "SS-#" is displayed, there is a select switch problem. If "JC-#" is displayed, there is a jammed column. Clear the jam and press a select button to acknowledge the correction. The motor will home at that point. If "Pb-#" is displayed, there is a problem with the board or motor switch on the column number shown.

### "SE-" - Select Switch Test

Press any select button, and the display will indicate the number of the select button pressed.  
Press select button 1 & 2 simultaneously to move to the next item on menu.

### "SOLt" - Sold Out Light Test

When set for discrete sold-out LEDs (dIS):

Press any select button. The sold-out lights will illuminate in order and the display will reflect the sold-out light being illuminated.

When set for "sold-out" message on display (nES):

Press any select button. The display will scroll "SL-1" through "SL-10".

NOTE: The sold-out lights will not be illuminated.

Press select button 1 & 2 simultaneously to move to the next item on menu.

### "SP-#" - Sold Out Paddle Test

Use this to test the sold-out switches if the vender is empty. The display will reflect any Sold-Out Paddles that are pressed, indicating that a column is full. The display will scroll through the columns in which the sold-out paddles are pressed.

Press select button 1 & 2 simultaneously to move to the next item on menu.

### "Su-#" - Sold Out Switch Test

Use this to test the sold-out switches if the vender is full. The display will reflect any Sold Out Switches that are pressed, indicating that the column is empty. The display will scroll through the columns that are sold out.

Press select button 1 & 2 simultaneously to move to the next item on menu.

### "nt-1" - Motor Test

Select Button 1: Press until desired motor # to run is shown on the display.

Select Button 2: Press to run the selected motor. The display will show "tEStin6" and the selected motor will run.

For the selected motor, sold out light #1 will flash if vend motor is not home, vend motor is not present or vend switch has a problem.

To home a motor if JC-# shows but there is not a jam, press and hold select button #1.

Press select button 1 & 2 simultaneously to move to the next item on menu.

### **"Cn" - Coin Mech Test**

Insert coins. The value of coins will be reflected on display.

Select Button 1: Press to display the Coin Mechanism setting.

Select Button 2: Press to return the coins inserted.

Press select button 1 & 2 simultaneously to move to the next item on menu.

### **"nA" - Note Acceptor Test**

Insert note. The value of note will be reflected on display.

Select Button 1: Press to display the Note Acceptor setting. ("LL" - low level, "HL" - high level or "ndb" - multi-drop note acceptor)

Select Button 2: Press to stack the note and cancel the credit.

Select Button 3: Press to return the note and cancel the credit.

Press select button 1 & 2 simultaneously to move to the next item on menu.

### **"dSP" - Display Test**

Press select button 1 and the display segments will illuminate in a scrolling manner, while blinking the exact change LED. Note: Display boards prior to December 1993 will not scroll, but if button 1 is held "rrrr" will flash continuously on the display.

Press select button 1 & 2 simultaneously to move to the next item on menu.

### **"UErS" - Version of Software**

Press any select button and the display will scroll the software revision level in the control box.

Example: 57 390-X. "X" represents the software revision level in the control box. All software prior to -7 will not have this diagnostic feature.

Press select button 1 & 2 simultaneously to move to the next item on menu.

### **"Undr" - Vender Identification**

Press any select button and the display will show 01, 02, or 03 for the vender type, that the software has determined, based on the select panel harness input. The vender types are:

"01" Coke venders

"02" Pepsi venders

"03" Generic venders

# SII QUICK REFERENCE MENU PROMPTS

## System Set-Up / Audit Menu

Hd  
rd  
C-d  
ESC  
    Pr  
    E-S4  
    E-S1  
    CR  
    nF  
COIn  
SOI  
S-P  
StS  
tInE  
dAtE  
LAOS  
LAOd  
PEr1  
Per2  
S-P2  
Pr2P  
Pr2d  
PrOn  
Lan6  
ECnt

## System Diagnostics Menu

SE-  
SOLt  
SP-#  
Su-#  
nt-1  
Cn  
nA  
dSP  
UErS  
Undr

**Press and hold select buttons 1 and 2 simultaneously to move through the menus from top to bottom.**

# ELECTRICAL PARTS AND FUNCTIONS

## **CORRECT CHANGE LAMP**

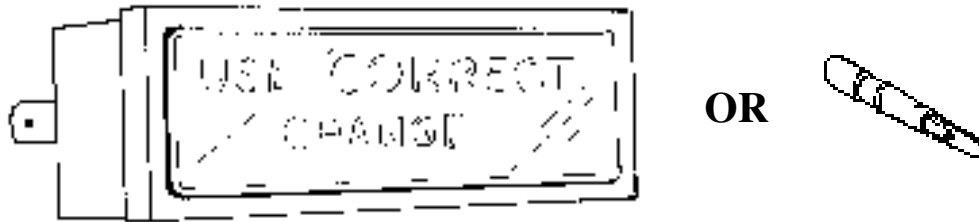

**OR**

Correct Change Lamp

The Correct Change Lamp is mounted in the Coin Insert Casting.

The Correct Change Lamp is controlled by the SII Controller Board and is "OFF" when coins are in the tubes of the Coin Changer.

## **SELECT SWITCH**

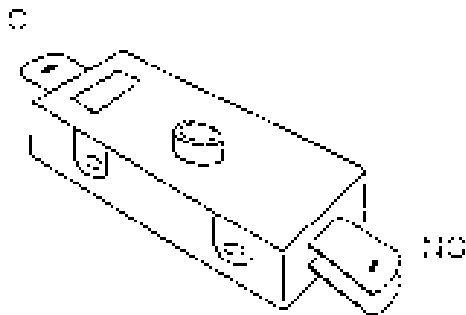

**OR**

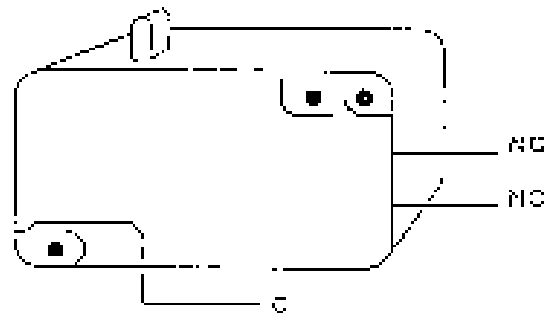

Select Switch

The Select Switch is located in the Select Panel behind the press button and is secured with two (2) screws.

The normally closed contact of the Select Switch is in the SII Control Board and Vend Motor Coil Circuits. This normally closed contact opens and the SII Control Board Circuit completes the Vend Motor Coil Circuit.

The normally open contact of the Select Switch has no function.

## SOLD OUT SWITCHES

The Sold Out Switch is located on the Front Mechanism Plate under the Vend Motor Cover.

The Sold Out Switch is the "snap in" type. To install, place the switch in position over the opening in the Front Mechanism Plate, push in and at the same time, slide to the right.

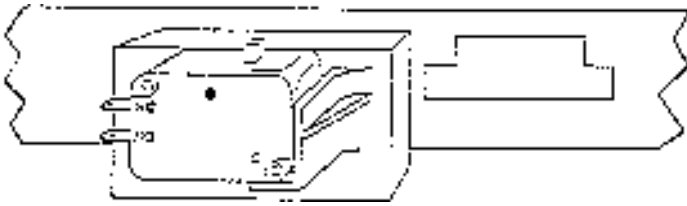

SOLD OUT SWITCH PACK

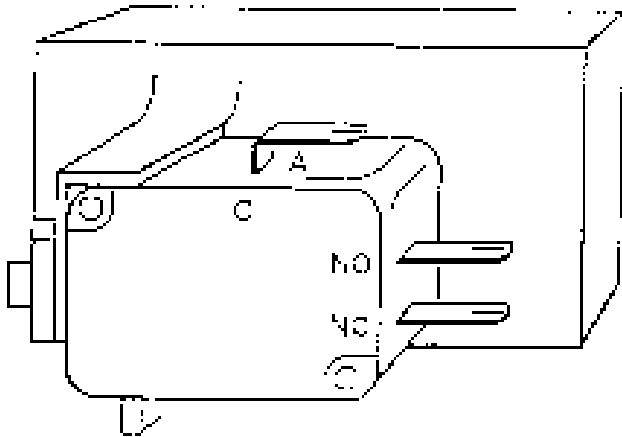
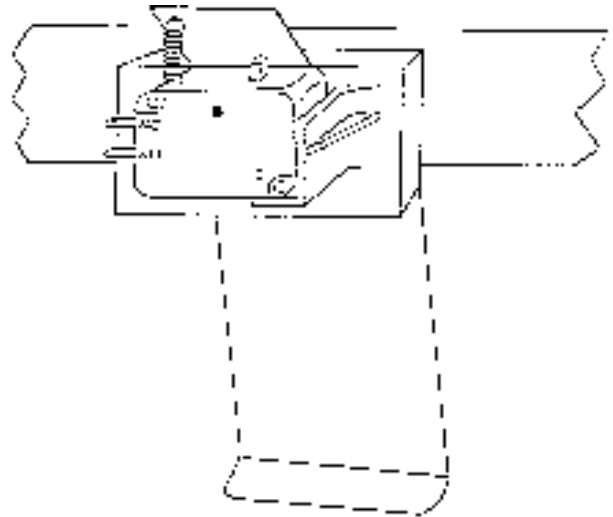

### (A) Vend Sold Out Switch

The normally closed contact of the Sold Out Switch has no function. The normally open contact of the Sold Out Switch is in the Sold Out Circuit (kept open by a can or bottle). When not kept open by a can or bottle, the normally open contact closes and completes the Sold Out Indicator Circuit via the SII Controller Board.

### Sold Out Indicator

The Sold Out Indicator is a bright red, low voltage LED. There is one for each selection.

The Sold Out Indicator is controlled by the SII Controller Board and is "off" when there is product in its column or the vender is programmed for sold out message at the sold out indication prompt of the Set-Up/Audit menu.



Sold Out Light

## VEND MOTOR

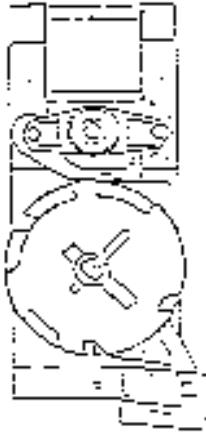

For Narrow Column

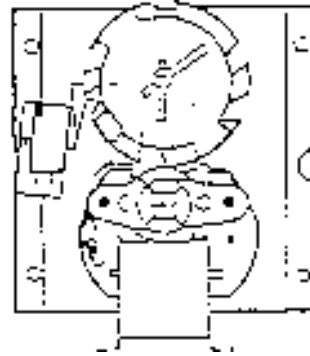

For Wide Column

The Vend Motor (one for each vending stack) is mounted on a bracket at the front of the Front Mechanism Plate.

The Vend Motor is in the Vend Motor Coil Circuit. The Vend Motor runs when a normally closed contact of the Select Switch, pushed, opens and signals the SII Controller Board to run the Motor.

The Vend Motor continues to run via the SII Controller Board while the Vend Motor Switch is on high side of Cam. The Vend Motor stops when the Vend Motor Switch Arm drops off the high side of the Vend Motor Cam, and the normally closed contact of the Vend Motor Switch closes, signaling the SII Controller Board to stop power to the Vend Motor Coil Circuit.

## VEND MOTOR SWITCH

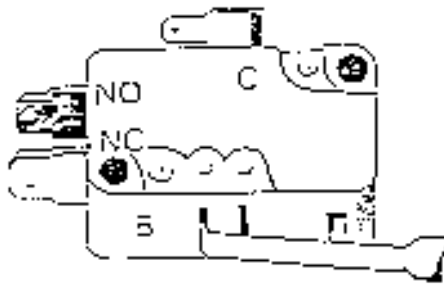

All Columns

### A. VEND MOTOR SWITCH

The **Vend Motor Switch**, one (1) for each circuit, is located on the Vend Motor Assembly and secured by two (2) screws.

The normally closed contact of the Vend Motor Switch is in the Vend Motor Coil Circuit. This normally closed contact opens in the Vend Motor Coil Circuit to keep the Vend Motor running, via the SII Controller Board, until the Arm of the Vend Motor Switch drops in the Cam notch and the Vend Motor stops.

The normally open contact of the Vend Motor Switch has no function.



## VEND MOTOR WIDE COLUMN

Mounted on the Vender with the Vend Switch on the left side (See Fig. 3). The Linkage and Drive Arm assembly is used to connect the Vend Motor to the Oscillator. (See Fig. 4)

Vend Motor Switch  
804,100,730.01

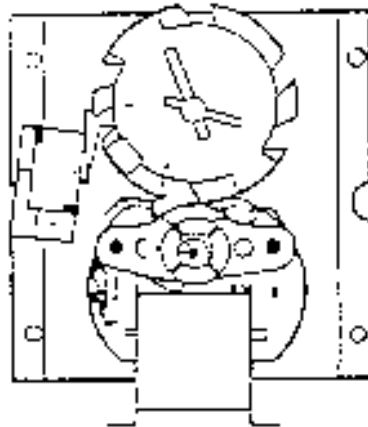

Fig. 3

Vend Motor - Wide Column  
572,070,100.03 - 1¼"  
565,070,200.03 - T-Models

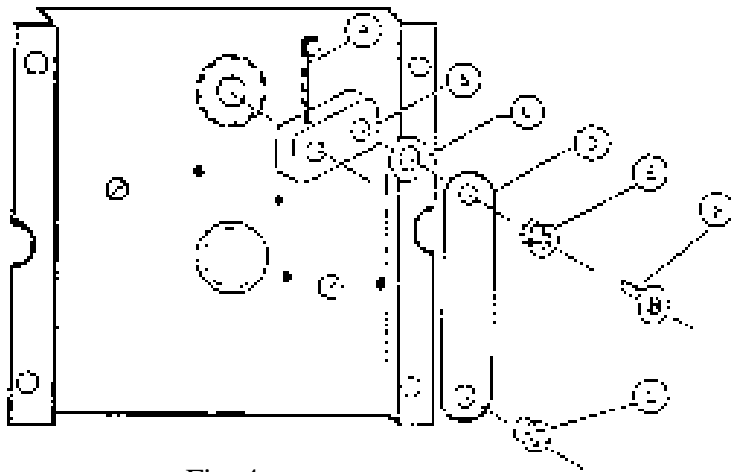



Fig. 4

### OLD STYLE

A. Drive Pin	900,901,940.01
B. Drive Arm	801,200,950.81
C. Washer	900,700,600.01
D. Linkage Arm	801,201,030.01
E. Nyliner (Top)	901,803,160.01
F. Sems Screw	900,301,640.01
G. Nyliner (Bottom)	901,804,770.01

### NEW PLASTIC STYLE

B. Drive Arm (Plastic)	801,806,160.21
D. Linkage Arm (Plastic)	801,806,170.01

  
Nyliner (Rear Stack)  
801,803,170.01

Cap Retainer  
801,807,870.11

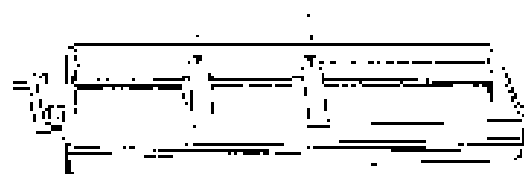

Oscillator Assembly  
491,070,900.03 - 1¼"  
497,071,000.03 - T-Models



  
Nyliner (Front Stack)  
901,804,230.01

Sold Out Spring  
#901,700,740.01

Sold-Out Switch Assy. Snap In  
#804,100,750.01  
(Insulator and Switch are one piece)

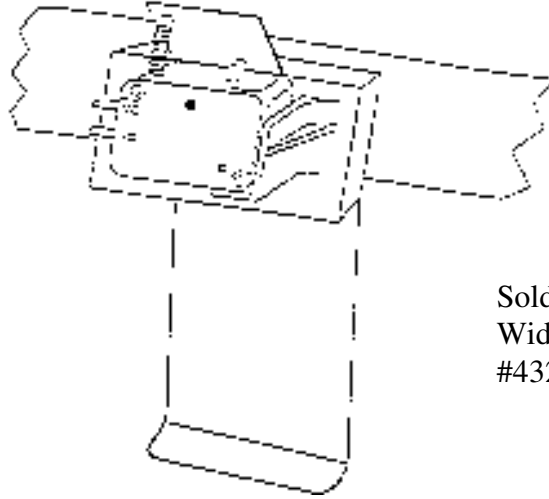

Sold-Out Paddle  
Wide and Narrow  
#432,070,190.13

### VEND MOTOR NARROW COLUMN

Mounted on the Vender with the Vend Motor Switch on the underside (See Fig. 1). The shaft of the Vend Motor slides into a slot in the Vend Rotor (See Fig. 2).

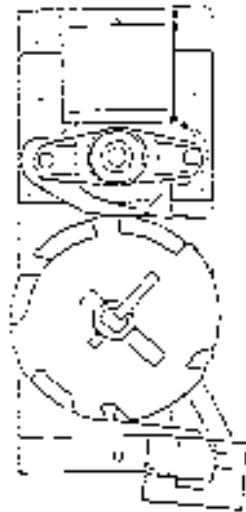

Vend Motor - Narrow Column  
#572,070,000.03 - 1¼"  
#565,070,100.03 - T-Models

Vend Motor Switch  
#804,100,730.01

Fig. 1

Vend Rotor  
#801,201,211.61 - 1¼"  
#801,201,220.01 - T Models, Wide  
#801,201,230.01 - T Models, Narrow

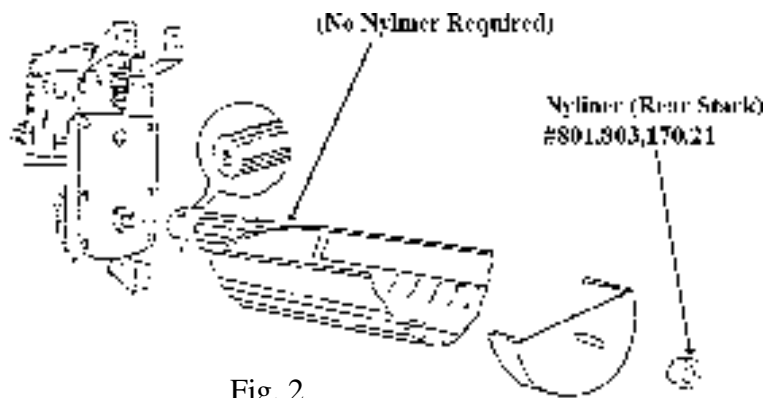

Fig. 2

## **PRODUCT SHIMMING**

Refer to the appropriate technical bulletin for proper set-up and vending procedures. Listed are a few of the more widely used Technical Bulletins relating to shimming.

- TB 450**      **Miscellaneous Worldwide Can Shimming, Shimless Stack Series 90**
- TB 451**      **Miscellaneous Worldwide Plastic Bottle Shimming, T-Models**
- TB 452**      **Miscellaneous Worldwide Non-Returnable Bottle Shimming, T-Models**
- TB 453**      **Miscellaneous Worldwide Plastic Bottle Shimming, Shimless Stack Series 90**
- TB 454**      **Miscellaneous Worldwide Non-Returnable Bottle Shimming, Shimless Stack Series 90**
- TB 455**      **Miscellaneous Worldwide Can Shimming, T-Models**
- TB 456**      **Miscellaneous Worldwide Returnable Bottle Shimming, Shimless Stack Series 90**
- TB 457**      **Miscellaneous Worldwide Returnable Bottle Shimming, Wide Stack Series 90**
- TB 473**      **Miscellaneous Worldwide Non-Returnable Bottle Shimming, Wide Stack Series 90**
- TB 474**      **Miscellaneous Worldwide Plastic Bottle Shimming, Wide Stack Series 90**
- TB 475**      **Miscellaneous Worldwide Can Shimming, Wide Stack Series 90**
- TB 476**      **Miscellaneous Worldwide Returnable Bottle Shimming, T-Models**

**For shimming of venders or products not listed in the above Technical Bulletins, call the Dixie-Narco Service Department or contact your Dixie-Narco Representative.**

## CAMS FOR VEND MOTORS

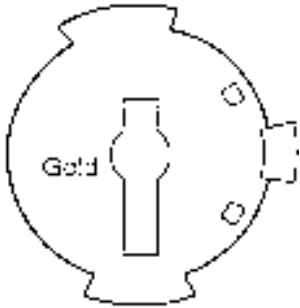

### 1. Adjustable Cam For:

- DNCB 1¼" deeper wide column.
- DNCB T-models single, double, or triple depth wide column.
- Color of Cam is Gold.
- Part #801,806,400.11

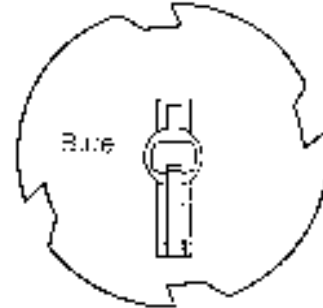

### 2. Vending Cam For:

- DNCB 1¼" deeper single double depth wide column.
- DNCB T-models single depth wide column.
- Color of Cam is Blue.
- Part #801,806,390.11

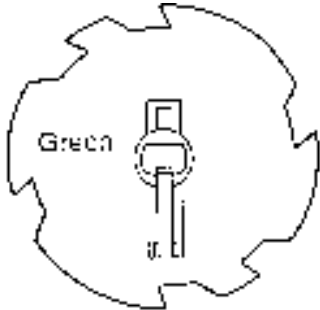

### 3. Vending Cam For:

- DNCB T-models double or triple depth wide column.
- Color of Cam is Green.
- Part #801,806,410.01

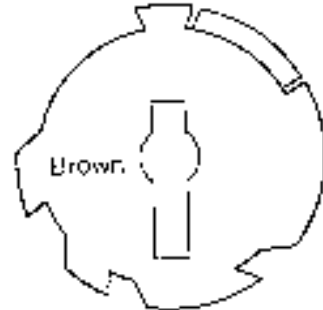

### 4. Adjustable Cam For:

- DNCB 1¼" deeper narrow column.
- DNCB T-models single, double, or triple depth narrow column.
- Color of Cam is Brown.
- Part #801,806,610.21

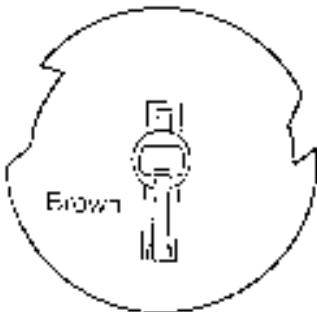

### 5. Vending Cam For:

- DNCB 1¼" deeper narrow column.
- DNCB T-models single, double, or triple depth narrow column.
- Color of Cam is Brown.
- Part #801,806,180.21

# CAM INSTALLATION AND REMOVAL

## **TO INSTALL A VENDING CAM:**

1. Select the Vending Cam required (See page 36).
2. Locate the Hub at the center of the Cam (See Fig. 6).
3. With the Hub facing you, slowly slide the Cam on the front shaft of the Vend Motor while depressing the Lock Tab. (See fig. 6).

NOTE: Reference below for timing of the Motors.

4. A distinct click will be heard, when the tab has locked into the locator hole of the Motor shaft.

**CAUTION:** Depress the Switch Arm when installing the Cam to prevent possible damage to the Switch Arm.

## **TO INSTALL AN ADJUSTABLE CAM:**

1. Select the Adjustable Cam required. (See page 36).
2. Locate the Lift Tab on the outer edge of the Cam. (See fig. 5).
3. With the Lift Tab facing you, align the slot of the adjustable Cam with the Locking Tab of the vending Cam.
4. Place the Adjustable Cam on the Vending Cam.

**CAUTION:** Depress the Switch Arm when installing the Cam to prevent possible damage to the Switch Arm.

5. Lift the Lock Tab of the Vending Cam, at the same time lift the Lift Tab of the Adjustable Cam and rotate the Adjustable Cam clockwise to the desired setting.

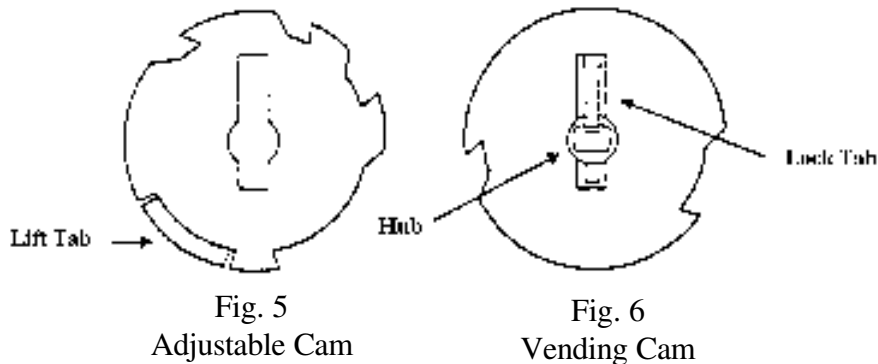

## **TO REMOVE AN ADJUSTABLE CAM:**

1. Lift the Lift Tab and rotate the Adjustable Cam clockwise until the Vending Cam Lock Tab is aligned with the slot of the Adjustable Cam.
2. Remove the Adjustable Cam from the shaft of the Motor.

## **TO REMOVE THE VENDING CAM:**

1. Depress (push in) the Lock Tab firmly to disengage it from the Motor shaft.
2. At the same time pull the Vending Cam towards you until it is removed from the Motor shaft.

## TIMING

### TO SET THE TIMING OF A NARROW COLUMN VEND MOTOR:

1. Make sure the hole through the rear shaft is in a horizontal plane. (If a pin were inserted in the hole, the pin would be horizontal.) See Fig. 8.
2. The Vend Rotor must be in the loading position when the Motor shaft is inserted in the end of the Rotor. See Fig. 8.
3. Insert the Motor shaft in the Rotor and secure the Motor.
4. Install the Vending Cam on the front shaft of the Motor making sure the Lock Tab is at the 9 o'clock position. See Fig 7.
5. Install the Adjustable Cam per the instructions given on the previous page.

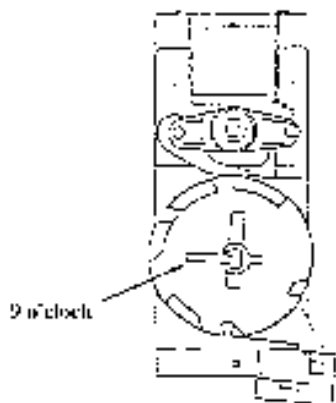

Fig. 7

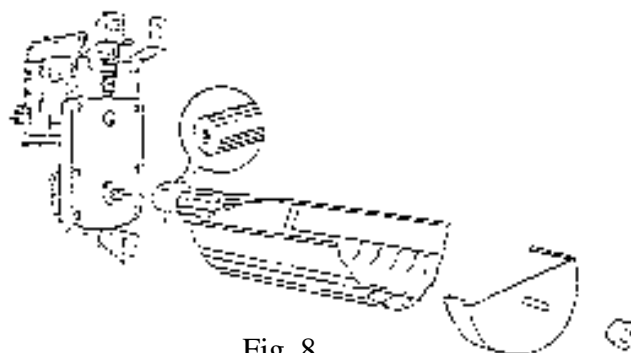

Fig. 8

### TO SET THE TIMING OF A WIDE COLUMN VEND MOTOR.

1. Make sure the hole through the rear shaft is in a horizontal plane. (If a pin were inserted in the hole, the pin would be horizontal). See Fig 10.
2. Slide the Drive Arm (with linkage attached) on the rear shaft as shown. See Fig. 10.
3. Secure by installing the Groove Pin.
4. With the Oscillator in position, align the hole in the Linkage Arm with the pin of the Oscillator.
5. Slide the Linkage on the pin.
6. Install the Vending Cam on the front shaft of the Motor making sure that the Lock Tab is at 6 o'clock as shown. See Fig. 11.

**NOTE:** When the screw holding the Linkage Arm to the Drive Arm is at the 12 o'clock position (See Fig. 10), the Lock Tab will be at the 6 o'clock position (See Fig. 11).

7. Install the Adjustable Cam per the instructions on page 37.

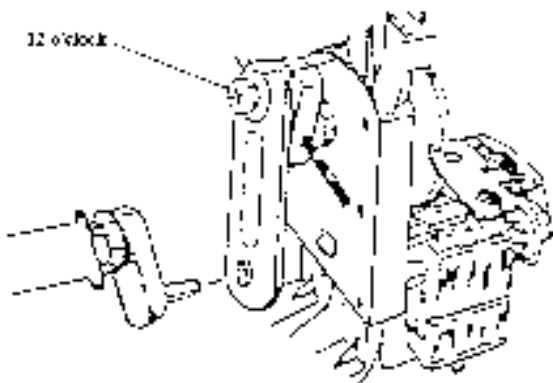

Fig. 10

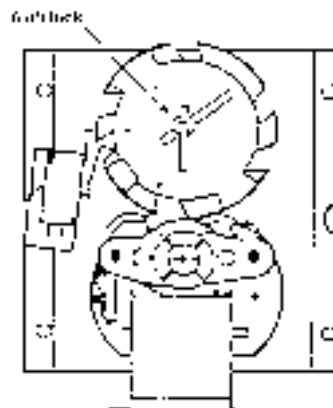

Fig. 11

## REAR SPACER

The Rear Spacer, one for each column, is located vertically at the rear of the column. The Latch Fingers or Springs, adjustable by hand, slide into the holes in the column wall for cans and other package settings.

Note: Rear Spacers with Springs are not shown.

See Fig. 13, the Latch Fingers are in the open position with the Lock Tabs disengaged.

See Fig. 14, the Latch Fingers are in the closed position with the Lock Tabs engaged. Make sure the tabs are in a locked position as shown, before loading the Vender.

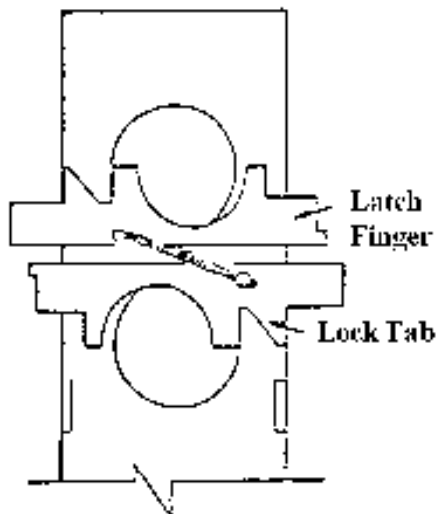

Fig. 13  
Rear Spacer

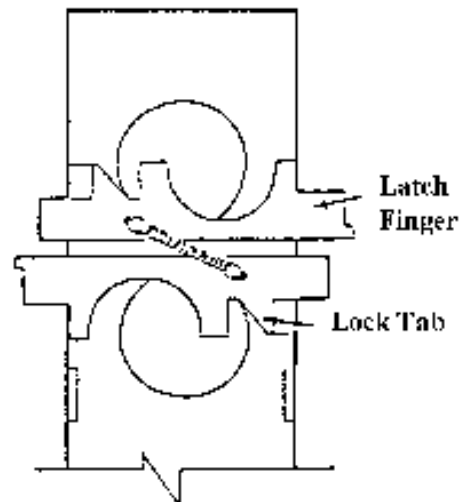
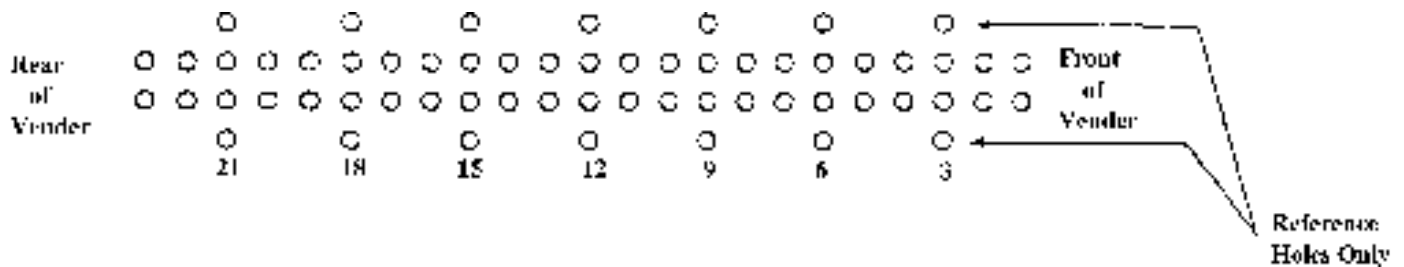

Fig. 14  
Rear Spacer

### FOR REFERENCE ONLY

Rear Spacer adjustment holes located in the sidewalls of the stacks.





## CLEANING THE VENDER

**DO NOT USE A WATER JET OR NOZZLE TO CLEAN THE VENDER.**

### SIGN FACE

The polycarbonate sign face requires proper cleaning to prolong the service life of this item. It is recommended that you periodically clean the sign face as follows:

1. Rinse the sign with a soft cloth or sponge soaked in warm water.
2. If necessary, use a mild soap to loosen any dirt or grime. To prevent damage, **DO NOT SCRUB** or use a brush or squeegee, as some signs have a clear ultraviolet resistant coating to prevent yellowing.
3. Repeat the above steps as necessary, then dry using a soft cloth to prevent spotting.

### CABINET

- \* Wash the cabinet with a good detergent or soap mixed in warm water.
- \* Wax the vender often with a good grade of automobile wax.
- \* Any corrosion inside the vender should be removed with fine steel wool and the area should be painted with aluminum paint.
- \* Repair any scratches on painted surfaces to prevent corrosion.

**WARNING: THE COMPRESSOR ELECTRICAL CIRCUIT IS ALWAYS LIVE WHEN THE PLUG IS CONNECTED TO AN ELECTRICAL OUTLET.**



### REFRIGERATION CONDENSER

- \* Check the condenser periodically for dirt or lint build up.
- \* Remove the build up with a brush or vacuum, or blow the dirt out of the condenser with compressed air and approved safety nozzle.
- \* Ensure nothing obstructs air intake at the bottom of the main door.
- \* Ensure nothing obstructs air exhaust at the rear of the cabinet.

### COIN ACCEPTOR

- \* Follow the Coin Acceptor Manufacturer's instructions.

### LUBRICATING THE VENDER

The vender refrigeration system does not require any field lubrication. The hermetic refrigeration system and fan motors are manufactured with lifetime lubrication.

<i>TIME</i>	<i>COMPONENT</i>	<i>LUBRICANT EXAMPLE</i>
<b>Every 6 Months (or as needed)</b>	<b>Main Door</b> 1. Lock Bolt & Nut Retainer 2. Hinge Pivot Points	Mechanics Friend
	<b>Inner Door</b> 1. Hinge Pivot Points	Mechanics Friend
<b>Every Year (or as needed)</b>	<b>Inner Door</b> 1. Door Gasket	Petroleum Jelly



# Temperature Control Adjustments

## Adjustment #1 - Temperature Adjustment

Turn the adjustment clockwise for colder product and counter-clockwise for warmer product. This will change the cut-out temperature only, the cut-in temperature remains constant.

## Adjustment #2 - Altitude Adjustment



### WARNING:

**DISCONNECT POWER TO THE VENDING MACHINE BEFORE PROCEEDING WITH THIS ADJUSTMENT.**

The control is factory set for an altitude of 152 M (500 ft.). For higher altitudes, adjust the inside range screws to prevent freeze-up of the product. Adjust the inside range screws as follows.

ALTITUDE		CUTLER-HAMMER 9531N272
Meters	Feet	Turn both screws counter clockwise
610	2,000	1/8 Turn
1219	4,000	1/4 Turn
1829	6,000	1/2 Turn
2438	8,000	5/8 Turn

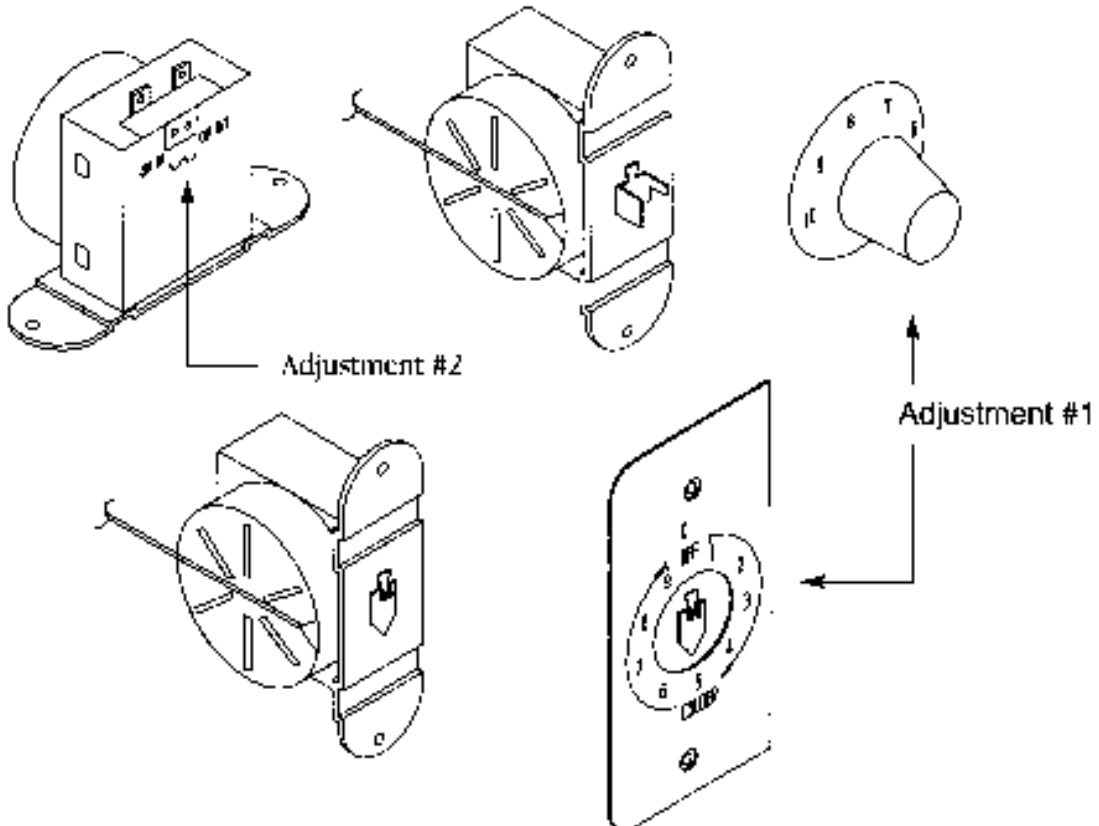

# **TROUBLESHOOTING**

## **SII VENDING**

1. **Problem:** Free vend on one column.  
**Troubleshooting:** A) Check selection price.  
B) Check for bad connections or broken, backed out, or crossed wires from vend motor to control board.  
C) Check for sticking select button.  
D) Replace control board.
  
2. **Problem:** One motor continues to home with door closed, shows "JC#" when in diagnostics.  
**Troubleshooting:** A) If using Mars Validator, ensure correct interface harness is used.  
B) Check for bad connections or broken, backed out, or crossed wires from vend motor to control board. (Note: Check wires on left side of vend motor cover.)  
C) Vend switch.  
D) Replace control board.
  
3. **Problem:** One column sold out, but still vends.  
**Troubleshooting:** A) Check sold-out switch.  
B) Check for bad connections or broken, backed out, or crossed wires from sold-out switch to control board. (Note: Check wires on left side of vend motor cover.)
  
4. **Problem:** Vender will not sequence (Coca-Cola only).  
**Troubleshooting:** A) Ensure wire #24 is in select panel harness and is in correct pin location.  
B) Check for bad connection or broken wire #24 in select panel harness.  
C) Make sure wire #24 is in correct location.  
D) Replace control board.
  
5. **Problem:** Free vend on one or more columns.  
**Troubleshooting:** A) Check secondary pricing program.  
B) Check for bad connections or broken, backed out, or crossed wires from vend motor to control board.  
C) Check for sticking select button.  
D) Check for bad vend motor switch.  
E) Replace control board.
  
6. **Problem:** Column Jackpots.  
**Troubleshooting:** A) Check problem column(s) in motor test.  
B) Check motor for:
  1. Syrup on brake.
  2. Locate/check brake spring.
  3. Check motor switch.C) Check wiring from/to motor switch of problem column.  
D) Check wiring at mate-n-lock on cabinet harness and cabinet extension harness.  
E) Replace motor.  
F) Replace control board.
  
7. **Problem:** Column will not vend.  
**Troubleshooting:** A) Go to diagnostics and test.  
B) Check for bad connection or broken, backed out, or crossed wires.

# **TROUBLESHOOTING**

## **SII COIN / CURRENCY**

1. Problem: Will not accept coins or bills.  
Troubleshooting: A) Check peripheral (1.0 Amp) fuse.  
B) Program SII control box to correct coin mech interface.  
C) Go to diagnostics and test.
  1. Will not take coins, replace coin mech.
  2. Still will not take coins, check connections and mech harness.D) Check for bad connections or broken, backed out, or crossed wires from validator/changer to control board.  
E) Replace control board.
2. Problem: Maka Validator steals bills.  
Troubleshooting: A) Check "Note Acceptor" program and ensure control board recognizes the bill acceptor correctly (i.e. HL). If not, replace with current Eprom or program vender to Escrow "ES-4".
3. Problem: Validator sometimes sets up credit and then steals bill.  
Troubleshooting: A) Check for proper interface harness.  
B) Check for bad connections or broken, backed out, or crossed wires from vend/sold-out harness.  
C) Replace validator.  
D) Replace control board.
4. Problem: Accepts coins and displays, but will not vend.  
Troubleshooting: A) Check coin mech.  
B) Check for bad connections or broken, backed out, or crossed wires from validator/changer to control board.  
C) Replace control board.
5. Problem: Incorrect change paid back, use correct change lamp stays on.  
Troubleshooting: A) Program control board to correct coin mech set.  
B) Replace control board.
6. Problem: In Escrow to Price, vender pays back coins.  
Troubleshooting: A) Install -6 Eprom or current Eprom.
7. Problem: Accepts \$1.00 coin, but will not pay back change when coin return pushed.  
Troubleshooting: A) Install -5 or -6 Eprom or current Eprom.
8. Problem: Cannot dump coins when in "Cd" mode.  
Troubleshooting: A) Check for bad connections or broken, backed out, or crossed wires from changer to control board.  
B) Check select switches and wiring.  
C) Replace coin mech.  
D) Replace control board.  
E) Ensure you are not using Mars International Executive or NRI Simplex changers.
9. Problem: BA-30 stealing bills.  
Troubleshooting: A) Check door switch.  
B) Check validator.  
C) Check interface harness.  
D) Install -6 Eprom or current Eprom.
10. Problem: Want to install a debit card system.  
Troubleshooting: A) Need a Rev -9 Eprom.  
B) Need to contact card system supplier for details.

# **TROUBLESHOOTING**

## **SII COIN / CURRENCY**

11. Problem: Will not accept \$1.00 coin.

Troubleshooting: 1) Program control board to accept \$1.00 coin.

A) Prior to -6 Eprom, follow these steps (except 5 select venders).

- Enter Set-Up/Audit Mode.
- Advance to "ESC" (Escrow) in menu.
- Press and hold select button #6 until display shows "ndOL". Continue holding select button #5 until display shows "dOL".

Note: On 5 select venders, you need to install current software.

B) Install current software.

# **TROUBLESHOOTING**

## **SII SOLD-OUT**

1. Problem: Sold-out lights stay on.  
Troubleshooting:
  - A) Check limited access program.
  - B) Check for crossed wires in cabinet harness and cabinet extension harness or loose wire harness connection.
  - C) Check for motors rubbing motor cover.
  - D) Install current Eprom.
  
2. Problem: Sold-out lamp comes on with product in column.  
Troubleshooting:
  - A) Check for sticking or bad select switch.
  - B) Check programming and ensure limited access is not on.
  - C) Check for bad connections or broken, backed out, or crossed wires from select switch to control board. (Note: Check wires on left side of motor cover.)
  - D) Check for motor rubbing motor cover.
  - E) Install current Eprom.
  
3. Problem: Sold-out switches work the incorrect column.  
Troubleshooting:
  - A) Ensure correct cabinet harness and select harness are being used.
  - B) Check for crossed wires in cabinet harness or cabinet harness extension.
  
4. Problem: #1 sold-out light flashing. Press diagnostics button and Jam 1, 2, 3, 4, 5, 6, 7, & 8 appears.  
Troubleshooting:
  - A) Check motor power fuse (2.5 Amp slowblow domestic, 4.0 Amp slow blow International).
  - B) Check for bad connections, broken, backed out, or crossed wires from motors and/or motor switches to control board.
  - C) Replace control board.
  - D) Check sold-out lamp diagnostics to ensure correct lamp comes on with correct column.
  
5. Problem: Sold-out lights flashing when main door is open.  
Troubleshooting:
  - A) Check for bad connections, broken, backed out, or crossed wires from motors and/or motor switches to control board.

# TROUBLESHOOTING

## SII SELECT PANEL / DISPLAY

1. Problem: Plug in vender and "rrrr" appears on display, vender will not function.  
Troubleshooting:
  - A) Press a select button to change message on display; this should clear "rrrr"s.
  - B) Remove power to vender for one minute, then power vender back up.
  - C) Check main power plug for loose connection.
  - D) Check for bad connections or broken wires from display to control board.
  - E) If sold out lights work, problem is a bad eprom or control board.
  - F) If sold out lights do not work, or there is no display, check the short power harness with four wires that goes from the top board to the bottom board.
  - G) Replace display board.
  - H) Replace control board.
  
2. Problem: Display will not function.  
Troubleshooting:
  - A) Check for bad connections or broken wires from display to control board.
  - B) Check motor power fuse.
  - C) Replace display board.
  - D) Replace control board.
  
3. Problem: Display shows \$1 and then increases in dollar increments.  
Troubleshooting:
  - A) Replace coin mech.
  - B) Install current Eprom.
  - C) Replace control board.
  
4. Problem: Cannot set price on a given selection.  
Troubleshooting:
  - A) Check for bad connections or broken wires from select switch to control board.
  - B) Check select switches.
  - C) Replace control board.
  
5. Problem: Vender changes a set vend price to .10¢ on selections on its own.  
Troubleshooting:
  - A) Check secondary pricing program.
  - B) Check for bad connections or broken wires from select switch to control board.
  - C) Replace control board. (Possible cold solder joints.)
  
6. Problem: Control board loses its memory when power is shut off to vender.  
Troubleshooting:
  - A) Replace control board.
  
7. Problem: Space to sales does not work properly when adding and deleting buttons.  
Troubleshooting:
  - A) Check for bad connections or broken wires from select switch to control board.
  - B) Replace control board.
  
8. Problem: Motor fuse blows when a given motor runs.  
Troubleshooting:
  - A) Check motor for short.
  - B) Check motor switch and motor wires for short.
  - C) Replace motor.
  
9. Problem: Board power fuse blows when supplying power.  
Troubleshooting:
  - A) Check changer and interface harness.
  - B) Check validator and interface harness.
  
10. Problem: Flashing decimal point.  
Troubleshooting:
  - A) Go to diagnostics.
    - All columns shown to be jammed.
    - Check motor fuse.
    - Go to note acceptor test; if it does not work then board is bad.

# TROUBLESHOOTING

## SII SELECT PANEL / DISPLAY

11. Problem: Plug in vender and "1-1" scrolls across display.  
Troubleshooting: A) Remove power to vender for one minute, then power vend back up.  
B) Check for bad connections or broken, backed out, or crossed wires in select panel harness.  
C) Replace display board.  
D) Replace control board.
12. Problem: Display shows "LOC".  
Troubleshooting: A) Can only be accessed via dex or hand-held.
13. Problem: Will not show vend price on display.  
Troubleshooting: A) Need Rev -7 or higher eprom.  
B) All vend prices on primary price have to be the same price, and all prices on secondary price have to be the same price.  
- To quick-set all prices, set vend price on #1 to price you require, then press select buttons 3 and 4 and hold for 10 to 15 seconds. All prices will change to the price programmed at #1 selection. Close the door and the display will now show the vend price.
14. Problem: When programming, the display takes 30 to 45 seconds to go from one program to another.  
Troubleshooting: A) Unplug the coin mech and then program the SII control box.
15. Problem: Display continuously scrolls "...uait..."  
Troubleshooting: A) Grey ribbon harness from top board to bottom board is not plugged in properly.

# **REFRIGERATION PARTS AND FUNCTIONS**

## **- MECHANICAL PARTS -**

### **COMPRESSOR MOTOR**

The compressor motor (sealed in the compressor housing) drives the compressor with a shaft that is shared by both parts. It is started by the temperature control switch and the starting relay. It is stopped by the temperature control switch, and, if it gets overloaded, by the thermal overload switch.

### **COMPRESSOR**

The compressor (sealed in the compressor housing) draws cold, low pressure refrigerant from the evaporator and pumps hot, high pressure refrigerant gas out to the condenser.

### **CONDENSER**

The condenser, located in the base of the vender, at the front, takes heat out of the hot, high pressure gas that comes from the compressor. The gas loses heat as it goes through the condenser coils, and changes into a liquid because it is still under pressure.

### **CONDENSER FAN**

The condenser fan (between the condenser and the compressor motor), first draws air from the outside of the vender through the condenser. This air takes heat from the condenser first and then is blown over the compressor housing from which it also takes heat before going back outside of the vender. The condenser fan runs when the compressor motor runs.

### **FILTER/DRYER**

The filter/dryer is in the liquid line between the condenser and the capillary tube. This dryer filters out any foreign particulate matter and also contains a desiccant to absorb any moisture that may be present in the system.

### **CAPILLARY TUBE**

The capillary tube (between the condenser and the evaporator in the refrigerant line) has a very small inside diameter, and serves to control the refrigerant flow from the condenser into the evaporator.

### **EVAPORATOR**

The evaporator (in the vender cabinet) takes heat from the air in the vender cabinet and gives this heat to the liquid refrigerant. The liquid refrigerant is evaporated (boiled off) as a gas, and the gas is drawn out by the compressor.

### **EVAPORATOR FAN**

The evaporator fan draws warm air from around the cans or bottles in the cooling compartment and blows it across the evaporator. As the air goes across the evaporator, it gives up heat to the evaporator, then goes back to the cans or bottles, and takes heat from them. This fan runs continuously when the vender is plugged in.



## **CONDENSATE PAN**

The condensate pan (located in the compressor compartment) collects the water which runs from the evaporator. The water is evaporated into the surrounding air by means of soakers. The soakers extend down into the pan to absorb the water. Exposure to the surrounding air evaporates the water in the soakers.

## **- ELECTRICAL PARTS -**

### **TEMPERATURE CONTROL**

The temperature control is the part that is made up of a control bulb connected by a small metal tube to a bellows. The control bulb is in a slot in the evaporator fan housing. The bellows and a switch known as the temperature control switch, are in the temperature control box which is fastened to the right side inside the venter.

The control bulb and the bellows have a vapor in them. When the temperature of the vapor in the bulb rises, it builds up pressure in the bellows tube. This pushes the bellows out. When the control bulb is cool, the vapor shrinks back, and the bellows pulls in. These movements, of the bellows, work the switch - called the temperature control switch - closing it when the bulb is heated and opening it when the bulb is cooled.

The contacts of the temperature control switch are in the compressor motor's running and starting circuits. They are also in the condenser fan motor circuit.

When the cabinet temperature gets up to the cut-in setting, the temperature control switch closes in the compressor motor's starting and running circuits and in the condenser fan circuit. When the cabinet temperature gets down to the cut-out setting, the temperature control switch opens in these circuits.

**CAUTION:** To adjust the temperature control see page 41.

### **THERMAL OVERLOAD ASSEMBLY**

The thermal overload is a temperature activated switch that interrupts power to the compressor when excessive temperatures occur. This switch protects the compressor from the damage that will occur if the compressor continues to operate under adverse conditions. The overload also opens under abnormally high amp draws, protecting the motor windings from damage. Frequent overload trips may lead to warm product and be the first indication of a dirty condenser or other refrigeration related problems that require attention.

### **STARTING RELAY**

The starting relay is a device that connects the start winding of the compressor during start up. The additional winding (start) helps the compressor motor come up to speed. Once it reaches speed the starting relay disconnects the start winding from the circuit.

## - ELECTRICAL OPERATION -

WHAT DOES IT	WHAT HAPPENS
<b>WHEN THE VENDER TEMPERATURE GETS UP TO THE CUT-IN SETTING:</b>	
The temperature control switch	closes the run winding circuit of the compressor motor. closes the start relay coil circuit. closes in the condenser fan motor circuit.
<b>THE HEAVY CURRENT, DRAWN BY THE RUN WINDING, ALSO FLOWS IN THE START RELAY COIL, AND:</b>	
The start relay coil	closes the start relay contacts and completes the start winding circuit of the compressor motor.
<b>WHEN THE COMPRESSOR MOTOR GETS UP TO SPEED</b>	
The spring in the relay	pushes the start relay contacts apart because
The start relay coil	no longer gets enough current to hold the contacts closed,
The start relay contacts	open in the start winding circuit of the compressor motor.
<b>IF THE COMPRESSOR MOTOR DRAWS TOO MUCH CURRENT AND CAUSES THE THERMAL OVERLOAD ASSEMBLY TO GET TOO WARM</b>	
The thermal overload switch	Opens the run winding circuit and disconnects the compressor motor.
<b>WHEN THE THERMAL OVERLOAD ASSEMBLY COOLS DOWN AGAIN</b>	
The thermal overload switch	Closes the run winding circuit and the start relay coil circuit of the compressor motor.
<b>WHEN THE VENDER TEMPERATURE GETS DOWN TO THE CUT-OUT SETTING</b>	
The temperature control switch	Opens in the run winding circuit of compressor motor. Opens in the starting relay coil circuit.

# COMPRESSOR MOTOR RUN WINDING CIRCUIT

SWITCHES IN THE WIRING	WHAT THE SWITCHES DO	WHAT MAKES THE SWITCHES WORK
1. Temperature control switch	1. Turns the compressor and condenser fan motor on and off.	1. The temperature in the vender has come up to the cut-in point (or gotten down to the cut-out point) set on the temperature control switch.
2. Start Relay	2. Turns the start windings on & off.	2. The presence or absence of heavy current switches the relay which energizes or de-energizes the start windings.
3. Thermal Overload Switch	3. Protects the windings of the compressor.	3. Current drawn by the motor or heat from the compressor can raise the temperature of the thermal overload switch cut-off, which removes power from the compressor.

---

# REFRIGERATION CIRCUIT DIAGRAMS

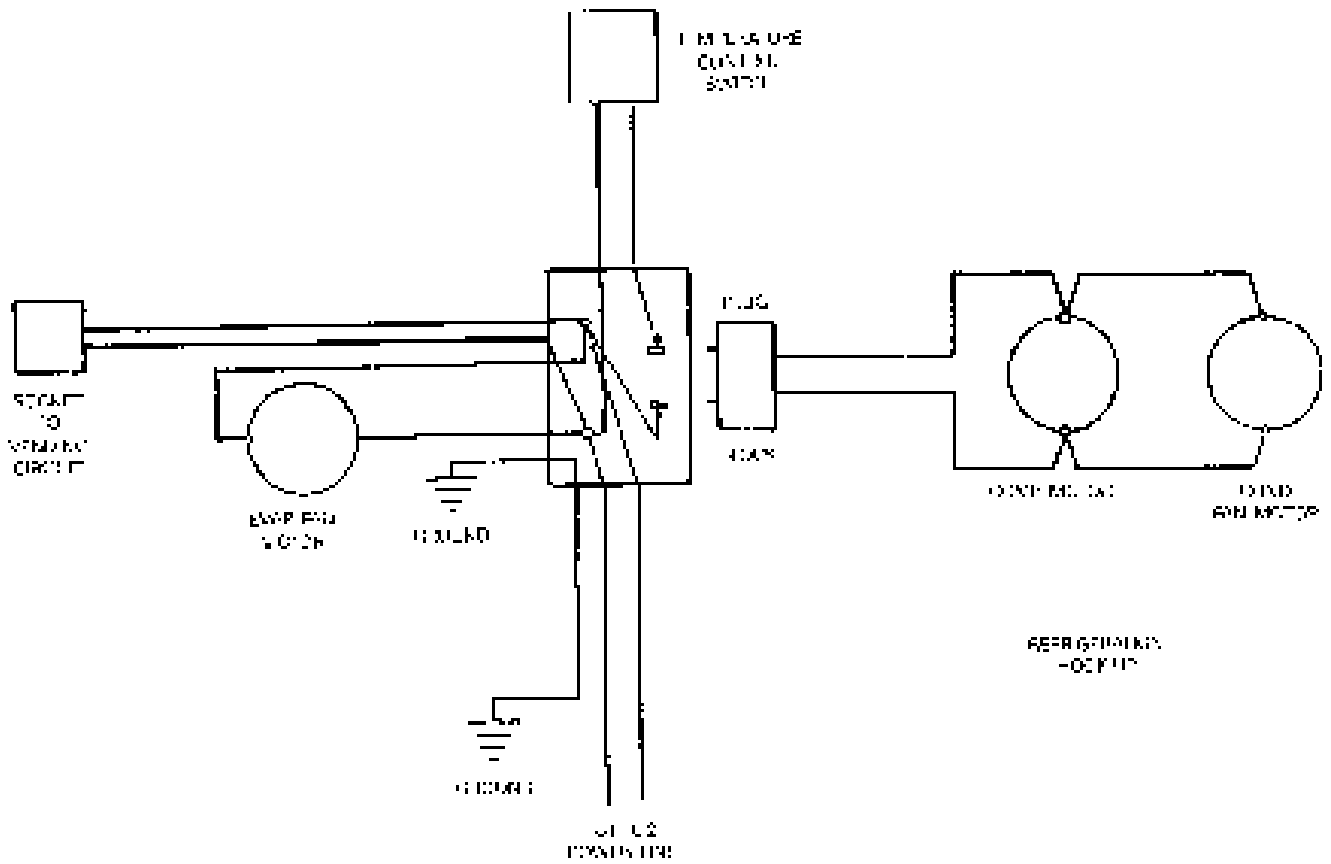

Tecumseh

Embraco

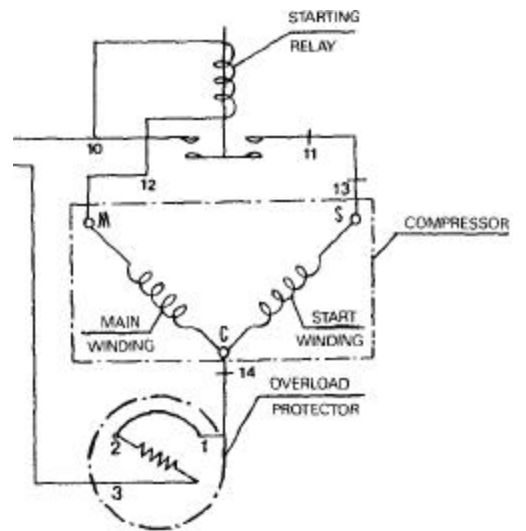
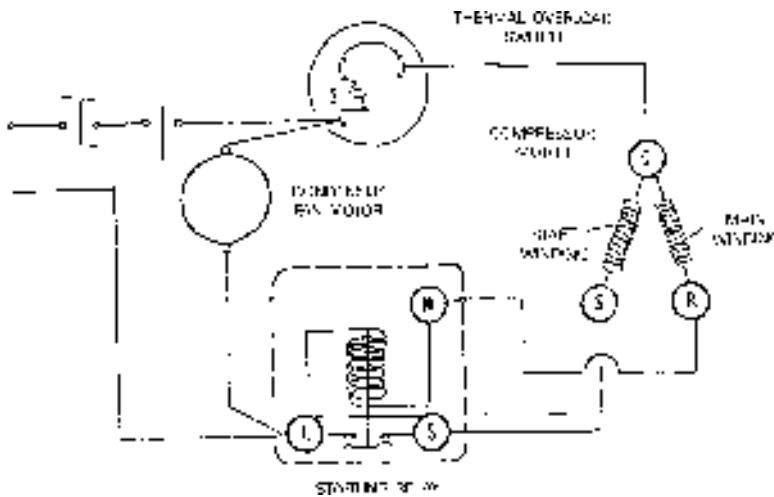

# REFRIGERATION CYCLE

WHAT DOES IT	WHAT HAPPENS
The rising temperature in the vender	Warms the temperature control bulb & the charge in it.
The charge in the control bulb	Expands in the control tube and stretches the temperature control bellows.
The bellows	Activates the temperature control switch.
The temperature control switch	Turns the compressor motor on. Turns the condenser fan motor on.
The compressor motor	Drives the compressor.
The condenser fan motor	Drives the condenser fan. Draws air through the condenser, cooling it and pushes air over the compressor cooling it.
The compressor	Draws low pressure refrigerant gas from the evaporator, compresses the gas, and pumps it to the condenser.
The condenser	Takes the heat out of the high pressure refrigerant gas.
More hot gas coming from the compressor	Pushes the liquid refrigerant into the capillary tube.
The capillary tube	Controls the flow of liquid refrigerant into the evaporator.
The evaporator	(Where the pressure is kept low by the suction of the compressor) Transfers heat from the air to liquid refrigerant.
The liquid refrigerant	Changes into gas at low pressure and is drawn into the compressor.
The falling temperature in the vender	Cools the temperature control bulb and the charge in it to a pre-determined temperature.
The charge in the control bulb	Shrinks & lets the temperature control bellows pull back
The bellows	Move and open the temperature control switch.
The temperature control switch	Turns the compressor motor off. Turns the condenser fan motor off.
The compressor	Stops.
The condenser fan motor	Stops.
(With the vender "Plugged In" the evaporator fan motor runs constantly)	

# **REFRIGERATION**

**Symptom: Product Hot**

**Possible Cause: Compressor Will Not Run.**

<b>WHAT TO CHECK</b>	<b>SOLUTION</b>
1. Is the vender plugged in?	1. <b>YES</b> , see step 2. <b>NO</b> , plug it in.
2. Is the compressor power cord plugged in?	2. <b>YES</b> , see step 3. <b>NO</b> , plug it in.
3. Is the temperature control on?	3. <b>YES</b> , see step 4. <b>NO</b> , turn it on.
4. Is there power at the wall outlet?	4. <b>YES</b> , see step 5. <b>NO</b> , consult an electrician.
5. Is the circuit breaker or fuse correct?	5. <b>YES</b> , see step 6. <b>NO</b> , replace or reset.
6. Is the vender power cord good?	6. <b>YES</b> , see step 7. <b>NO</b> , replace.
7. Is the compressor power cord good?	7. <b>YES</b> , see step 8. <b>NO</b> , replace.
8. Is the temperature control bulb located properly?	8. <b>YES</b> , see step 9. <b>NO</b> , correct.
9. Is the temperature control operational?	9. <b>YES</b> , see step 10. <b>NO</b> , replace.
10. Is the thermal overload operational?	10. <b>YES</b> , see step 11. <b>NO</b> , replace.
11. Is the start relay operational?	11. <b>YES</b> , see step 12. <b>NO</b> , replace.
12. Is the compressor operational?	12. <b>YES</b> , see step 13. <b>NO</b> , replace.
13. If all of the above steps fail...	13. Consult the Dixie-Narco Factory Service at 1-800-688-9090. Note: Have the vender model and serial number available.

# REFRIGERATION

## Symptom: Product Hot

Possible Cause: Compressor Starts But Will Not Keep Running

WHAT TO CHECK	SOLUTION
1. Is the temperature control knob set on its highest setting?	1. <b>YES</b> , see step 2. <b>NO</b> , adjust the knob to a higher setting.
2. Domestically, is the voltage supply within +/- 10% of rating on serial plate?	2. <b>YES</b> , see step 3. <b>NO</b> , consult the power company.
3. Is the condenser clear of obstruction?	3. <b>YES</b> , see step 4. <b>NO</b> , clear or clean..
4. Is the condenser fan blade turning?	4. <b>YES</b> , see step 5. <b>NO</b> , free the obstruction or replace the blade if needed.
5. Is the condenser fan motor operational?	5. <b>YES</b> , see step 6. <b>NO</b> , replace.
6. Is the temperature control operational?	6. <b>YES</b> , see step 7. <b>NO</b> , replace
7. Is the tube from the compressor to the condenser free of kinks?	7. <b>YES</b> , see step 8. <b>NO</b> , repair or replace
8. Is the capillary tube free of kinks?	8. <b>YES</b> , see step 9. <b>NO</b> , replace.
9. Is the thermal overload operational?	9. <b>YES</b> , see step 10. <b>NO</b> , replace.
10. Is the start relay operational?	10. <b>YES</b> , see step 11. <b>NO</b> , replace.
11. If all of the above steps fail...	11. Consult the Dixie-Narco Factory Service at 1-800-688-9090. NOTE: Have the vender model and serial number available.

# **REFRIGERATION**

Symptom: Product Hot

Possible Cause: Miscellaneous

WHAT TO CHECK	SOLUTION
1. Is the evaporator fan motor working?	1. <b>YES</b> , see step 2. <b>NO</b> , replace motor.
2. Has the refrigeration system lost its charge?	2. <b>YES</b> , replace the refrigeration system. <b>NO</b> , see step 3.
3. If all of the above steps fail...	3. Consult the Dixie-Narco Factory Service at 1-800-688-9090. NOTE: Have the vender model and serial number available.



# REFRIGERATION

Symptom: Product Cold But Not Cold Enough

Possible Cause: Compressor Runs But Will Not Cool Product

WHAT TO CHECK	SOLUTION
1. Is the temperature control knob set properly?	1. <b>YES</b> , see step 2. <b>NO</b> , set properly.
2. Domestically, is the voltage supply between 103V and 127V?	2. <b>YES</b> , see step 3. <b>NO</b> , call the power company.
3. Is the temperature control probe located properly?	3. <b>YES</b> , see step 4. <b>NO</b> , correct.
4. Is the condenser clear of obstruction?	4. <b>YES</b> , see step 5. <b>NO</b> , clear, clean, or space the vender.
5. Is the evaporator fan free of obstruction?	5. <b>YES</b> , see step 6. <b>NO</b> , free any obstruction or replace.
6. Is the condenser fan free of obstruction?	6. <b>YES</b> , see step 7 <b>NO</b> , free any obstruction or replace.
7. Is the evaporator free of ice?	7. <b>YES</b> , see step 8 <b>NO</b> , defrost and check the following: gasket seal, port door seal, refrigerant charge.
8. Is the temperature control operational?	8. <b>YES</b> , see step 9 <b>NO</b> , replace.
9. Is the evaporator fan operational?	9. <b>YES</b> , see step 10 <b>NO</b> , replace.
10. Is the condenser fan motor operational?	10. <b>YES</b> , see step 11. <b>NO</b> , replace.
11. Is the refrigerant tubing free of kinks?	11. <b>YES</b> , see step 12. <b>NO</b> , repair or replace.
12. Is the overload operational?	12. <b>YES</b> , see step 13. <b>NO</b> , replace.
13. Is the start relay operational?	13. <b>YES</b> , see step 14. <b>NO</b> , replace.
14. Is there refrigerant in the system?	14. <b>YES</b> , see step 15. <b>NO</b> , charge system and check for leaks.
15. If all of the above steps fail...	15. Consult the Dixie-Narco Factory Service at 1-800-688-9090. NOTE: Have the vender model and serial number available.

# REFRIGERATION

Symptom: Product Too Cold or Frozen

Possible Cause: Compressor Runs Too Long or Continuously

WHAT TO CHECK	SOLUTION
1. Is the temperature control knob set properly?	1. <b>YES</b> , see step 2. <b>NO</b> , set properly.
2. Is the temperature control bulb located properly.	2. <b>YES</b> , see step 3. <b>NO</b> , correct..
3. Is the temperature control operational?	3. <b>YES</b> , see step 4. <b>NO</b> , replace.
4. Does the evaporator frost over completely while the system is running?	4. <b>YES</b> , see step 5. <b>NO</b> , check for leaks or a low charge.
5. If all of the above steps fail...	5. Consult the Dixie-Narco Factory Service at 1-800-688-9090. NOTE: Have the vender model and serial number available.

# **REFRIGERATION**

## **Symptom: Noisy Refrigeration Unit**

<b>WHAT TO CHECK</b>	<b>SOLUTION</b>
1. Are the refrigerant lines free of contact with surfaces?	1. <b>YES</b> , see step 2. <b>NO</b> , correct..
2. Is the condenser fan blade obstructed or damaged?	2. <b>No</b> , see step 3. <b>YES</b> , free any obstructions or replace the blade if need..
3. Is the evaporator fan blade obstructed or damaged?	3. <b>NO</b> , see step 4. <b>YES</b> , free any obstructions or replace the blade if needed..
4. Is the compressor noisy?	4. <b>NO</b> , see step 5. <b>YES</b> , replace.
5. If all of the above steps fail...	5. Consult the Dixie-Narco Factory Service at 1-800-688-9090. NOTE: Have the vender model and serial number available.

# REFRIGERATION

## Symptom: Excessive Condensate

WHAT TO CHECK	SOLUTION
1. Is the door sealed properly? (This can be checked by inserting a piece of paper, thin plastic, or paper currency between the cabinet and the door seal when the main door is open. When the door is closed properly the paper should exert some resistance as it is pulled out.)	1. <b>YES</b> , see step 4. <b>NO</b> , Ensure the door is closed tightly. If door still does not seal properly, see step 2.
2. Is the motor cover interfering with the inner door?	2. <b>YES</b> , reinstall the motor cover properly. <b>NO</b> , see step 3.
3. Has the machine been vandalized?	3. <b>YES</b> , replace necessary components. <b>NO</b> , see step 4.
4. Are the drain pan soakers positioned properly?	4. <b>YES</b> , see step 5. <b>NO</b> , place soakers upright in pan so that air will flow over and through the soakers..
5. Are there fourteen fiberglass soakers in the pan?	5. <b>YES</b> , see step 6. <b>NO</b> , place fourteen fiberglass soakers in the condensate pan.
6. Are the condensate & evaporator free from obstruction?	6. <b>YES</b> , see step 7. <b>NO</b> , remove all debris and/or cans from the area around the evaporator and condenser. Clean the evaporator and condenser coils with a stiff brush or compressed air.
7. Is the delivery door misaligned?	7. <b>YES</b> , A. Level the vender properly. B. Align the inner and outer doors so that the delivery door does not stick open. <b>NO</b> , see step 8.
8. If all of the above steps fail?	8. Consult the Dixie-Narco Factory Service at 1-800-688-9090. NOTE: Have the vender model and serial number available.

## SMALL PARTS

ITEM	PART NUMBER	PART NAME AND DESCRIPTION
1a	804,700,550.21	Sold Out Light, 2 VDC Coke VRV SII
1b	804,700,520.01	Sold Out Light, 2 VDC All Non VRV SII Venders s/n prior to 0001-6156AR
1c	804,700,570.01	Sold Out Light, 2 VDC All Non VRV SII Venders s/n 0001-6156AR & higher
2a	804,100,740.11	Select Switch, 7UP & Coke SII VRV
2b	804,100,760.11	Select Switch, Pepsi & Generic SII
3	804,100,750.11	Sold Out Switch SII
4	804,100,730.01	Vend Motor Switch SII
5a	804,906,680.91	Control Box SII
5b	804,909,690.01	SII Control Box Exports
6a	565,070,100.03	Vend Motor Assy., Brown Cam T Narrow SII
6b	572,070,000.03	Vend Motor Assy., Brown Cam Std. Narrow SII
7a	565,070,200.03	Vend Motor Assy., Green Cam T SII Wide
7b	565,070,400.03	Vend Motor Assy., 20 oz. Cam T SII Wide
7c	572,070,100.03	Vend Motor Assy., Blue Cam Std. SII Wide
8	804,100,770.21	Door Switch SII
9a	804,906,690.41	S/A Display Board Pepsi, Generic
9b	804,908,230.01	S/A Display Board SII 7UP only
9c	804,907,010.51	S/A Display Board SII Coke VRV
9d	804,907,020.11	S/A Display Board SII Coke Non VRV
10	903,835,120.21	Program Label SII (-9)
11	804,800,710.01	1.6 Amp Slow Blow Fuse
12	804,800,720.01	1 Amp Slow Blow Fuse
13	804,800,730.01	2.5 Amp Slow Blow Fuse
14	804,907,830.11	External Dex Harness (Service Only)
15	804,910,930.01	4 Amp Fuse (For use with Executive Coin Mech) Rapid Blow
16	804,907,780.01	EPROM 6.7 (For use with Executive Coin Mech)
17	903,828,820.01	SII Price Label
18	801,807,730.01	SII Motor Cover Guard
19	572,010,040.03	SII Control Box Button Cover (Service Only)
20	903,901,300.31	SII Coin Mech Label
21	495,050,030.03	SII Mount, 180 CC VRV -2 per
22	65x417	SII Fuse Holder (Available from Eastlake Only)
23	803,840,890.01	4.0A Label
24	801,807,850.01	Trim, Vend Motor Cover

Part numbers are subject to change without notice.

## WIRING HARNESESSES

ITEM	PART NUMBER	PART NAME AND DESCRIPTION
1	See List Below	Door Harness (From select panel to control board)
A	804,906,860.11	SII 7 Select VRV CC 368/440
B	804,906,870.21	SII 9 Select VRV CC 348/414
C	804,906,880.11	SII 6 Select VRV CC 276/360
D	804,907,720.11	SII 8 Select VRV CC 368/440/501/600
E	804,908,850.01	SII 8 Select Non VRV CC 368/440/501/600
F	804,907,910.01	SII 6 Select Non VRV CC 276/360
G	804,908,420.01	SII 5 Select VRV CC 180
H	804,907,950.01	SII 8 Select PMC 368/440/501/600
I	804,907,960.01	SII 10 Select PMC 348/414
J	804,907,940.01	SII 6 Select PMC 276/360
K	804,908,030.21	SII 10 Select 7UP/Dr. Pepper 348/414
L	804,908,020.21	SII 8 Select 7UP/Dr. Pepper 368/440/501/600
M	804,908,010.21	SII 6 Select 7UP/Dr. Pepper 276/360
N	804,906,900.21	SII 10 Select Generic 348/414
O	804,906,450.21	SII 8 Select Generic 368/440/501/600
P	804,906,460.11	SII 6 Select Generic 168/276
Q	804,907,970.01	SII 5 Select Generic 180
2	See List Below	Cabinet Harness (From sold out switches and vend switches)
A	804,906,370.21	SII 501/600
B	804,906,380.21	SII 368/440
C	804,906,390.11	SII 348/414
D	804,907,100.21	SII 432/360
E	804,907,030.11	SII 300/180
F	804,906,410.21	SII 276/168
3	See List Below	Motor Harness (From coils of vend motors)
A	804,906,500.21	SII 501/600
B	804,906,490.31	SII 368/440
C	804,906,480.11	SII 348/414
D	804,907,090.31	SII 360/432
E	804,907,170.01	SII 300/180
F	804,906,510.21	SII 276
4a	804,906,650.41	Price Display Harness SII (All)
4b	804,908,130.01	Extended Price Display Harness (EL# 2x5997)
5a	804,907,880.21	Motor Extension Harness (180's & 72" Dr. Pepper) (From board to motor harness) 62"
5b	804,906,340.11	Motor Extension Harness SII (All Others) (From board to motor harness) 90"
6	804,906,470.21	Cabinet Extension Harness SII (All) (From board to cabinet harness)
7a	804,906,620.01	Coin Mech Harness MC 5000 or L-plus Non Coke SII (EL# 940063)
7b	804,908,110.01	Extended Coin Mech Harness MC 5000 or L-plus Non Coke SII (EL# 94x79)
8a	804,906,660.11	Coin Mech Harness Multidrop Coke SII
8b	804,908,260.01	Extended Coin Mech Harness Multidrop Coke SII (EL# 2x6029)

Part numbers are subject to change without notice.

## WIRING HARNESESSES

ITEM	PART NUMBER	PART NAME AND DESCRIPTION
9a	804,906,640.31	Low Level Note Acceptor Harness SII (EL# 025830)
9b	804,908,120.01	Extended Low Level Note Acceptor Harness SII (EL# 2x5996)
10	804,907,760.01	SA Executive Coin Mech Harness
11	804,907,800.11	High Level Note Acceptor Harness for Mars (EL# 2x5894)
12	804,907,710.01	High Level Note Acceptor Harness for Maka (EL# 2x5896)
13	804,907,820.01	Coin Mech Harness to Interface Maka (EL# 2x5903)
14	804,907,790.21	High Level Note Acceptor Harness for CBA-2 (EL# 2x5897)
15	804,907,890.01	BDV Coin Mech Harness (EL# 2x5928)
16	804,907,840.11	"All for One" Low Level/High Level Note Acceptor Harness (EL# 2x5955)
17	804,908,320.01	S/A Harness, SII Power for DBA and Coin Mech (EL# 2x5995)
18a	804,909,560.01	DBA Note Acceptor to MDB Coin Mech Harness (EL# 2x6082)
18b	804,909,570.01	DBA Note Acceptor to MDB Coin Mech Harness, Extended (EL# 2x6083)
19a	804,910,080.01	DEX Interface 9 Pin Harness to PC
19b	804,910,090.01	DEX Interface 25 Pin Harness to PC
20a	804,909,040.01	BA-30 SII MDB Interface Harness (Coinco #407420)
20b	804,909,050.01	BA-30 SII MC5000 Interface Harness (Coinco #407518)

Part numbers are subject to change without notice.

## SELECT PANEL ASSYS.

ITEM	PART NUMBER	PART NAME AND DESCRIPTION
1a	565,152,010.03	Select Panel Assy. FLS SII 180/300
1b	555,150,100.03	Assy., Front Control Panel FLS 5-FL 300
2a	565,150,300.03	Select Panel Assy. FLS/CK (Circular or Flat) 368/440
2b	469,050,500.03	Assy., Front Control Panel 368/440
3a	565,151,800.03	Select Panel Assy. FLS SII 276/360
3b	477,050,400.03	Assy., Front Control Panel 360
4a	572,052,400.03	Select Panel Assy. Pepsi MC SII 368/440
4b	480,050,200.33	W/A Select Panel - 8 PMC
5a	572,052,300.03	Select Panel Assy. Pepsi MC SII 348/414
5b	479,050,500.03	W/A Select Panel -10 PMC
6a	565,151,200.03	Select Panel Assy. Pepsi MC SII 276
6b	488,050,200.23	W/A Select Panel
7a	565,150,600.03	Select Panel Assy. Pepsi MC SII 360/432
7b	488,050,200.23	W/A Front Control Panel 6 FL Mag.
8a	581,050,100.03	Select Panel Assy. 7UP SII 414
8b	901,805,960.01	Select Panel 7UP-10
9a	581,050,400.13	Assy., Select Panel 7UP SII 368/501/440/600
9b	801,805,970.01	Select Panel, 7UP-8
10a	565,150,900.03	Select Panel Assy. GR SII 348/414
10b	471,050,300.03	Assy., Front Control Panel -10
11a	565,151,600.03	Select Panel Assy. GR SII 368/440
11b	469,050,500.03	Assy., Front Control Panel -8
12a	578,050,100.03	Select Panel Assy. Coke - 6 SII Non VRV 360
12b	801,805,730.01	Select Panel Coke - 6
13a	579,050,100.03	Select Panel Assy. Coke - 7 SII Non VRV 368/440/501/600
13b	801,805,740.01	Select Panel Coke - 7
14a	572,052,200.03	Select Panel Assy. Coke - 7 SII VRV 368/440/501/600
14b	801,807,180.31	Select Panel Lens Coke -7
15a	572,052,000.03	Select Panel Assy. Coke - 9 SII VRV 348/414
15b	801,807,180.31	Select Panel Lens Coke -9
16a	572,052,700.03	Select Panel Assy. Coke - 6 SII VRV 360
16b	801,807,180.31	Select Panel Lens Coke -6

Part numbers are subject to change without notice.



## SII MAIN DOOR ASSYS. AND W/A

ITEM	PART NUMBER	PART NAME AND DESCRIPTION
1a	565,152,400.03	Assy., Main Door FLS SII 300
1b	493,051,000.03	W/A Main Door FLS 276/300
2a	565,152,000.03	Assy., Main Door FLS SII 180
2b	548,051,000.03	W/A Main Door FLS 180
3a	565,151,900.03	Assy., Main Door FLS SII 276
3b	493,051,000.03	W/A Main Door FLS 276/300
4a	565,151,700.03	Assy., Main Door FLS SII 360/522
4b	478,150,100.03	W/A Main Door FLS SII 360/ 368
5a	565,150,200.03	Assy., Main Door FLS SII 368/501
5b	478,150,100.03	W/A Main Door FLS 360/368
6a	565,152,900.03	Assy., Main Door FLS 440/600 SII
6b	565,153,000.03	W/A Main Door FLS 440/600
1a	480,052,000.03	Assy., Main Door PC SII 440 Pepsi
1b	480,150,100.03	W/A Main Door 432/440 PC
2a	479,250,000.03	Assy., Main Door PC SII 414 Pepsi
2b	479,150,100.03	W/A Main Door 414 PC
3a	565,151,100.03	Assy., Main Door PC SII 300 Pepsi
3b	561,050,600.03	W/A Main Door PC MC SII 300
4a	565,151,000.03	Assy., Main Door PC SII CR 276 Pepsi
4b	561,050,600.03	W/A Main Door PCMC SII 276
5a	565,150,500.03	Assy., Main Door PCMC SII 360 Pepsi
5b	482,150,100.03	W/A Main Door PCMC SII 360/368
6a	565,150,400.03	Assy., Main Door PCMC SII 348 Pepsi
6b	481,150,100.03	W/A Main Door PCMC SII 348
7a	565,150,100.03	Assy., Main Door PCMC SII 368/501 Pepsi
7b	482,150,100.03	W/A Main Door PMC SII 360/368
1a	581,050,000.03	Assy., Main Door B7 SII 414 7UP
1b	467,150,100.03	W/A Main Door B7 SII 414
2a	455,150,500.03	Assy., Main Door B7 SII 440/600 7UP
2b	455,150,500.13	W/A Main Door B7 440/600
3a	581,050,300.03	Assy., Main Door B7 SII 368/501 7UP
3b	462,150,100.03	W/A Main Door B7 368/501
4a	466,150,200.03	Assy., Main Door B7 SII 348 7UP
4b	466,150,100.03	W/A Main Door B7 348
1a	565,150,800.03	Assy., Main Door (10QB) CR SII 348
1b	470,150,100.03	W/A Main Door CR 348, 360/368 SII
2a	565,151,500.03	Assy., Main Door (8QB) CR SII 368/501 Generic
2b	470,150,100.03	W/A Main Door CR 348, 360/368/501
3a	565,153,500.03	Assy., Main Door (6QB) CR SII 360/522 Generic (Double Validator Hole)
3b	470,151,200.03	W/A Main Door CR 360/522

Part numbers are subject to change without notice.

## SII MAIN DOOR ASSYS. AND W/A

ITEM	PART NUMBER	PART NAME AND DESCRIPTION
1a	578,050,000.03	Assy., Main Door CC-6 Non VRV SII 360
1b	443,050,500.03	W/A Main Door 360 Non VRV SII Coke
2a	579,050,000.03	Assy., Main Door CC-7 Non VRV SII 368/501
2b	492,050,100.03	W/A Main Door 368/501 SII Coke
3a	570,050,500.03	Assy., Main Door CC-7 VRV SII 440/600
3b	573,050,100.03	W/A Main Door 414/440/432/600 VRV
4a	570,050,600.03	Assy., Main Door CC-7 VRV SII 368/501
4b	570,050,100.03	W/A Main Door 360, 522, 368/501 VRV Coke
5a	570,050,700.03	Assy., Main Door CC-8 VRV SII 368/501
5b	570,050,100.03	W/A Main Door 360, 522, 368/501 VRV
6a	571,050,100.03	Assy., Main Door CC-9 VRV SII 348
6b	570,050,100.03	W/A Main Door 360/522/368/501 VRV Coke
7a	572,051,900.03	Assy., Main Door CC-8 VRV SII 440
7b	573,050,100.03	W/A Main Door 414/440/600/432 VRV Coke
8a	573,050,200.03	Assy., Main Door CC-9 VRV SII 414
8b	573,050,100.03	W/A Main Door 414/440/600/432 VRV Coke
9a	567,050,300.03	Assy., Main Door CC-6 VRV SII 276
9b	567,050,200.03	W/A Main Door CC 276/300 VRV Coke
10a	578,050,300.03	Assy., Main Door CC -6 VRV SII 360
10b	570,050,100.03	W/A Main Door 360/522/368/501 VRV Coke
11a	582,050,000.03	Assy., Main Door CC -6 VRV SII 432
11b	573,050,100.03	W/A Main Door 432/414/440/600 VRV Coke
12a	572,051,900.03	Assy., Main Door CC -8 VRV SII 440/600
12b	573,050,100.03	W/A Main Door 600/414/440/432 VRV Coke
13a	566,050,600.03	Assy., Main Door CC -5 VRV SII 180
13b	566,050,300.03	W/A Main Door 180 VRV Coke
1a	565,152,300.03	Assy., Main Door SII 180 Display
1b	548,050,100.03	W/A Main Door Flat 180/168
2a	565,152,200.03	Assy., Main Door SII 368/501 Display
2b	478,150,100.03	W/A Main Door 368/501

Part numbers are subject to change without notice.

# GLOSSARY

1. **DEX** - **Direct Exchange of Data**
2. **"Dixie" Bus** - Dixie-Narco Serial Communication Specification to allow Dixie-Narco to add extra features without affecting current vender designs.
3. **IR** - **Inredred**
4. **LCD** - **Liquid Crystal Diodes**
5. **LED** - **Light Emitting Diodes**
6. **MDB** - **Multi-Drop Bus** - Coca-Cola Serial Communication Specifications. Used in all Dixie S-2 can venders.
7. **NAMA** - **National Automatic Merchandising Association**
8. **UCS** - **Uniform Communications Standards**
9. **UCC** - **Uniform Code Council**



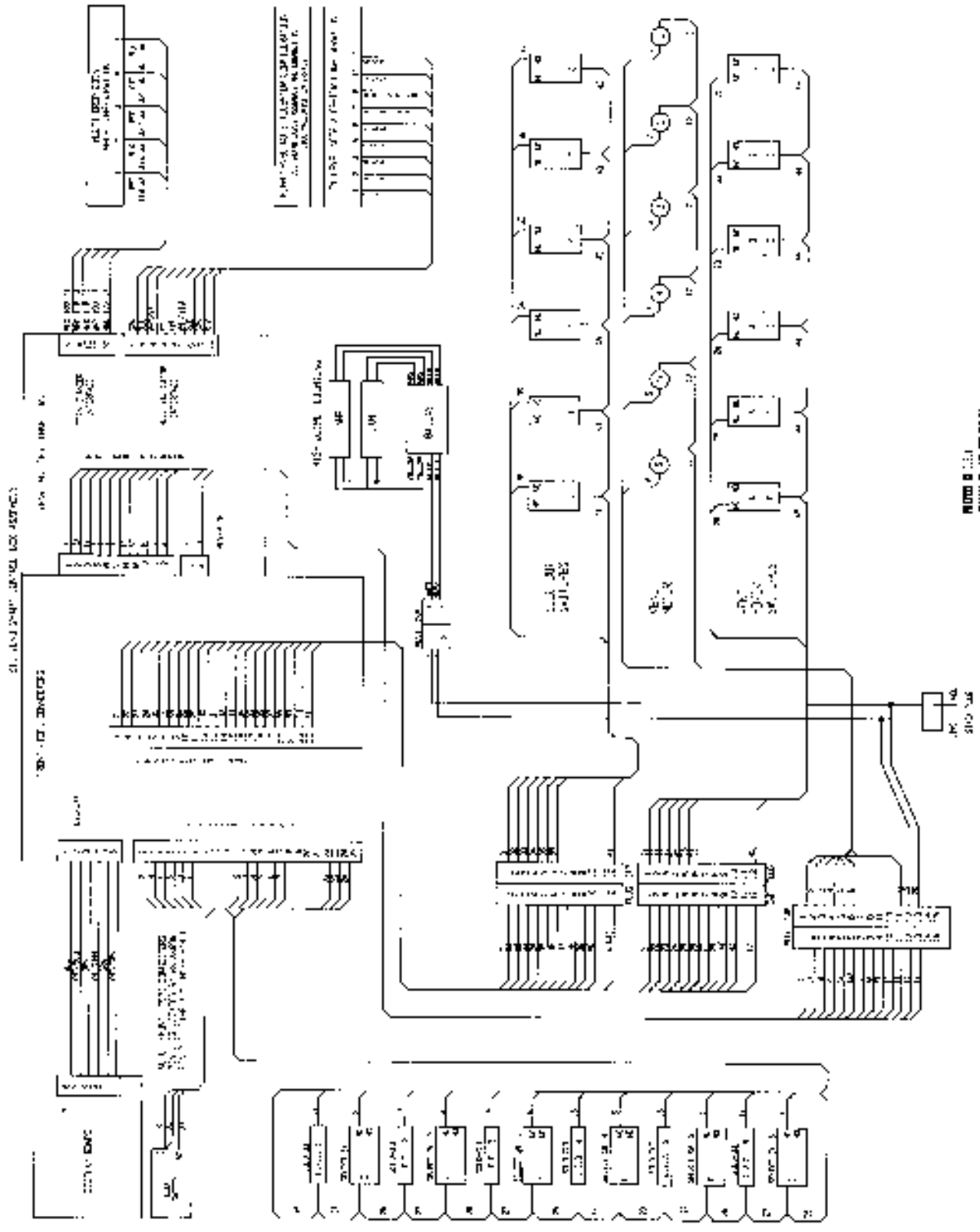

WIRE GAUGE

16-20 FT. WIRE	16 AWG
20-30 FT. WIRE	18 AWG
30-40 FT. WIRE	20 AWG
40-50 FT. WIRE	22 AWG
50-60 FT. WIRE	24 AWG
60-70 FT. WIRE	26 AWG
70-80 FT. WIRE	28 AWG
80-90 FT. WIRE	30 AWG
90-100 FT. WIRE	32 AWG

2. ALL WIRE MUST BE INSULATED WITH RUBBER TUBING OR ELECTRICAL TAPE.

FIG. 15.

1	2	3	4	5	6	7	8	9	10	11	12	13	14	15	16	17	18	19	20	21	22	23	24	25	26	27	28	29	30	31	32	33	34	35	36	37	38	39	40	41	42	43	44	45	46	47	48	49	50
---	---	---	---	---	---	---	---	---	----	----	----	----	----	----	----	----	----	----	----	----	----	----	----	----	----	----	----	----	----	----	----	----	----	----	----	----	----	----	----	----	----	----	----	----	----	----	----	----	----

**Dixie-Marco**  
 SERIES 11 - VEHICLES  
 10 SELECT - 382/182

FIG. 15  
 MAIN WIRING



Wiring Diagram for 1967-1968 Buick Wildcat

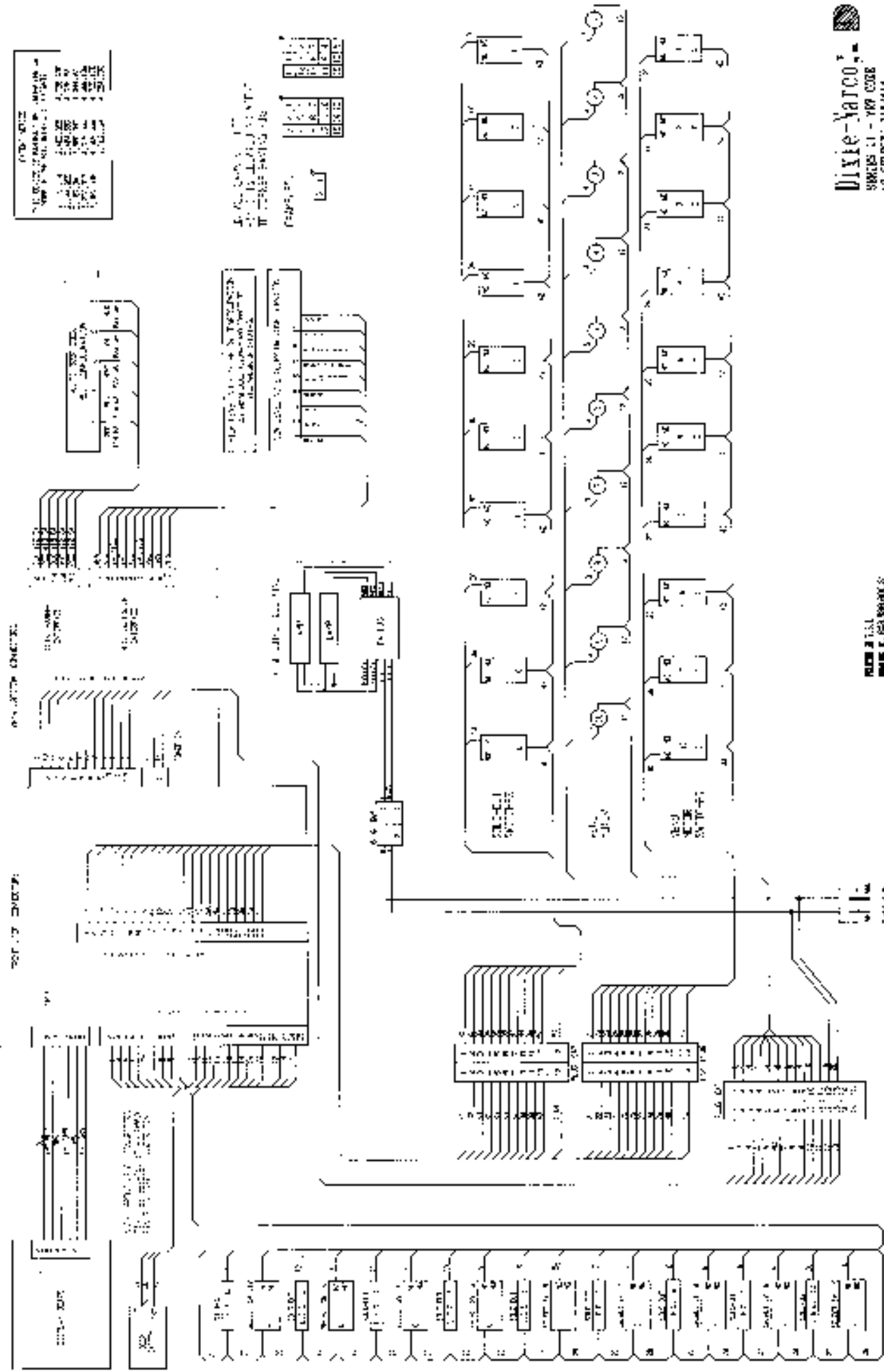

1967-1968 Buick Wildcat

15A	Ignition
10A	Headlights
5A	Taillights
2A	Interior

1967-1968 Buick Wildcat

15A	Ignition
10A	Headlights
5A	Taillights
2A	Interior

1967-1968 Buick Wildcat

15A	Ignition
10A	Headlights
5A	Taillights
2A	Interior

Dixie-Yarco  
 SERIES 11 - 1967 CODE  
 17 SECT: 346714

Wiring Diagram  
 Buick Wildcat

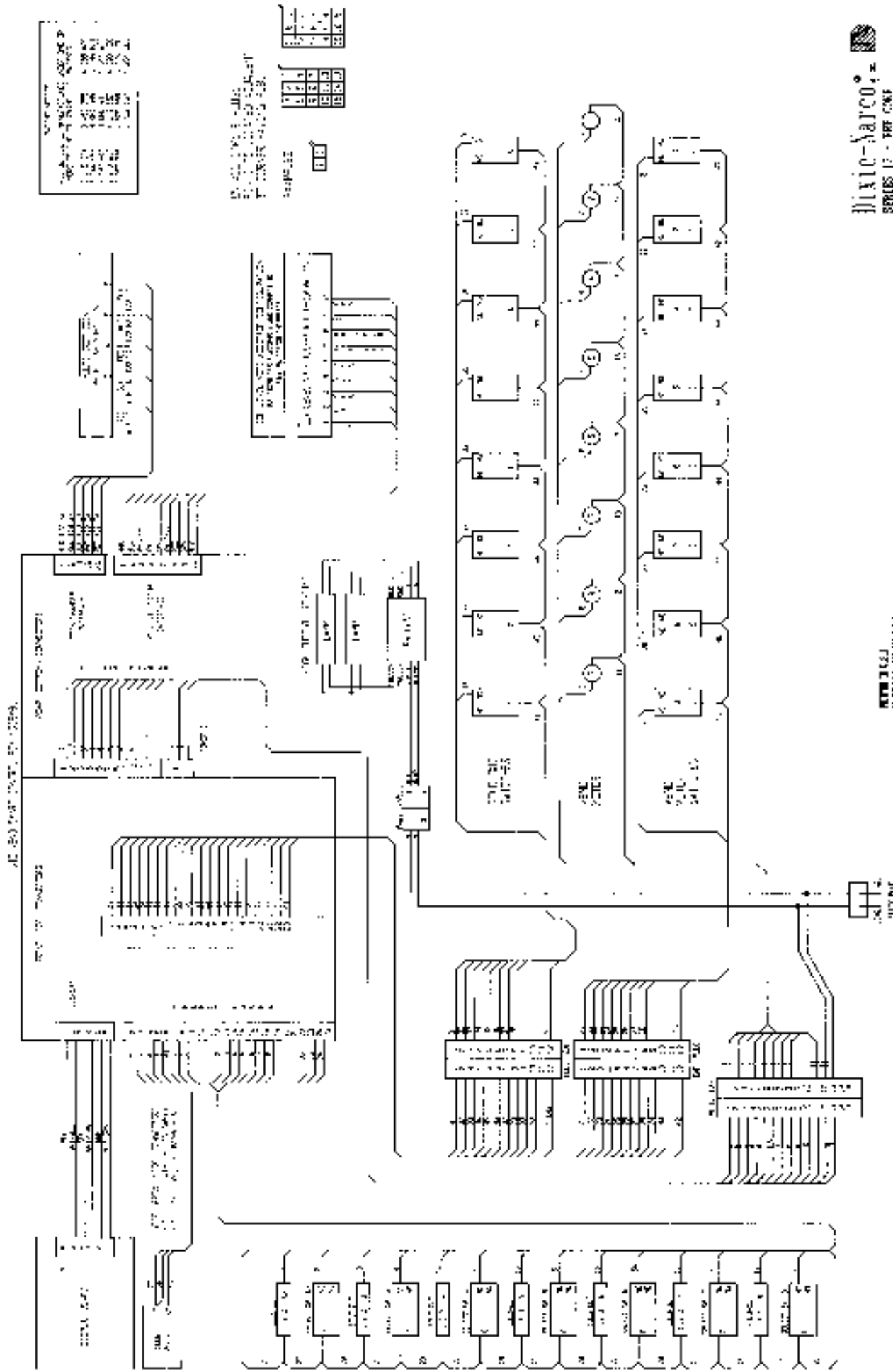

RELAY CONTACTS

1	2	3	4	5	6	7	8	9	10
11	12	13	14	15	16	17	18	19	20
21	22	23	24	25	26	27	28	29	30
31	32	33	34	35	36	37	38	39	40
41	42	43	44	45	46	47	48	49	50

RELAY COILS

1	2	3	4	5	6	7	8	9	10
11	12	13	14	15	16	17	18	19	20
21	22	23	24	25	26	27	28	29	30
31	32	33	34	35	36	37	38	39	40
41	42	43	44	45	46	47	48	49	50

**Dixie-Aarco, Inc.**  
 SERIES 12 - PRE CODE  
 12 SERIAL 1011010

DATE 12-15-64  
 MADE IN U.S.A.



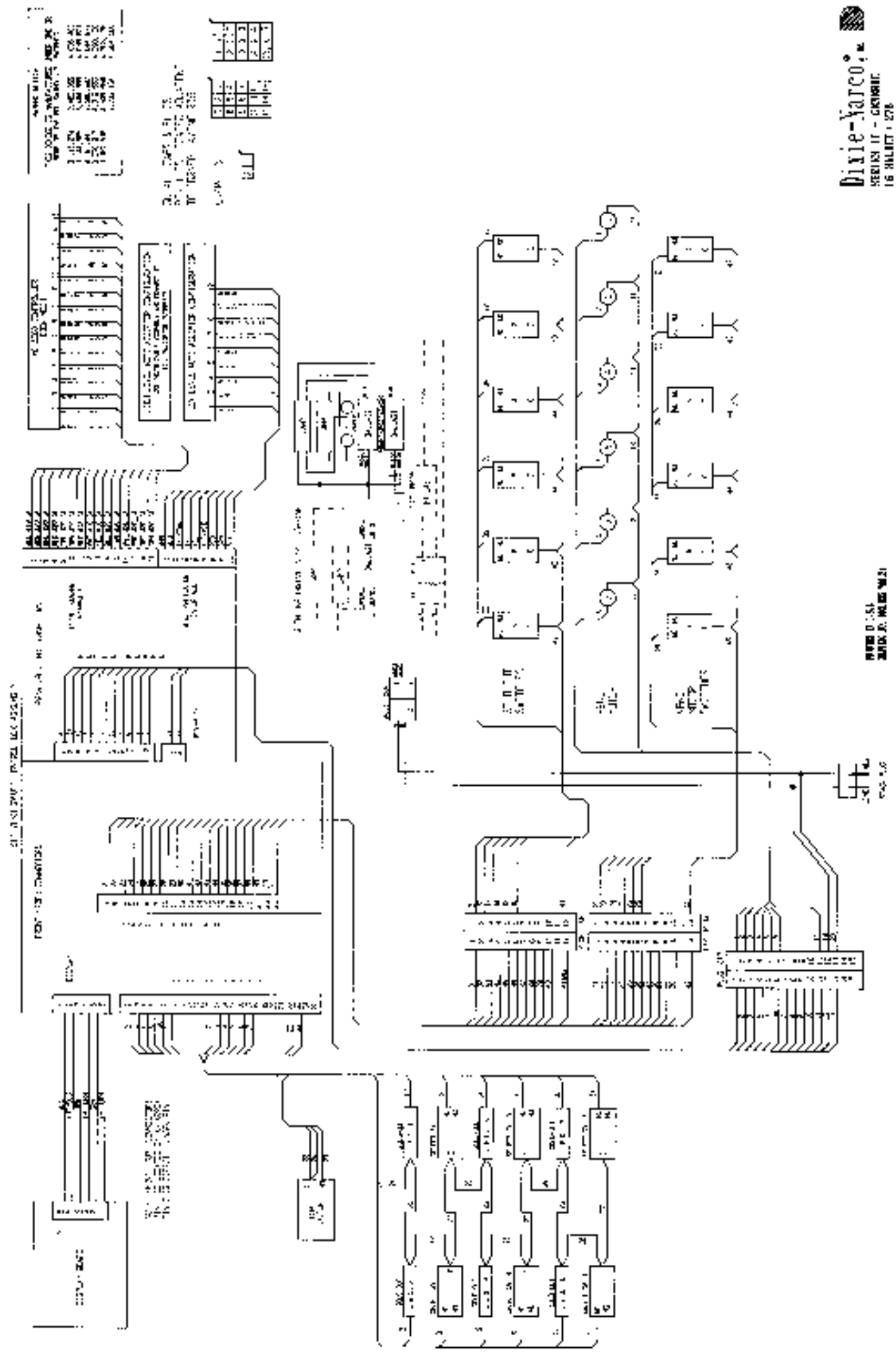

120V CONTROL

120V MOTOR

RELAY

SOLENOID

LAMP

FUSE

SWITCH

...

...

...

...

...

...

...

...

...

...

...

...

...

...

...

...

...

...

...

...

...

...

...

...

...

...

...

...

...

...

...

...

...

...

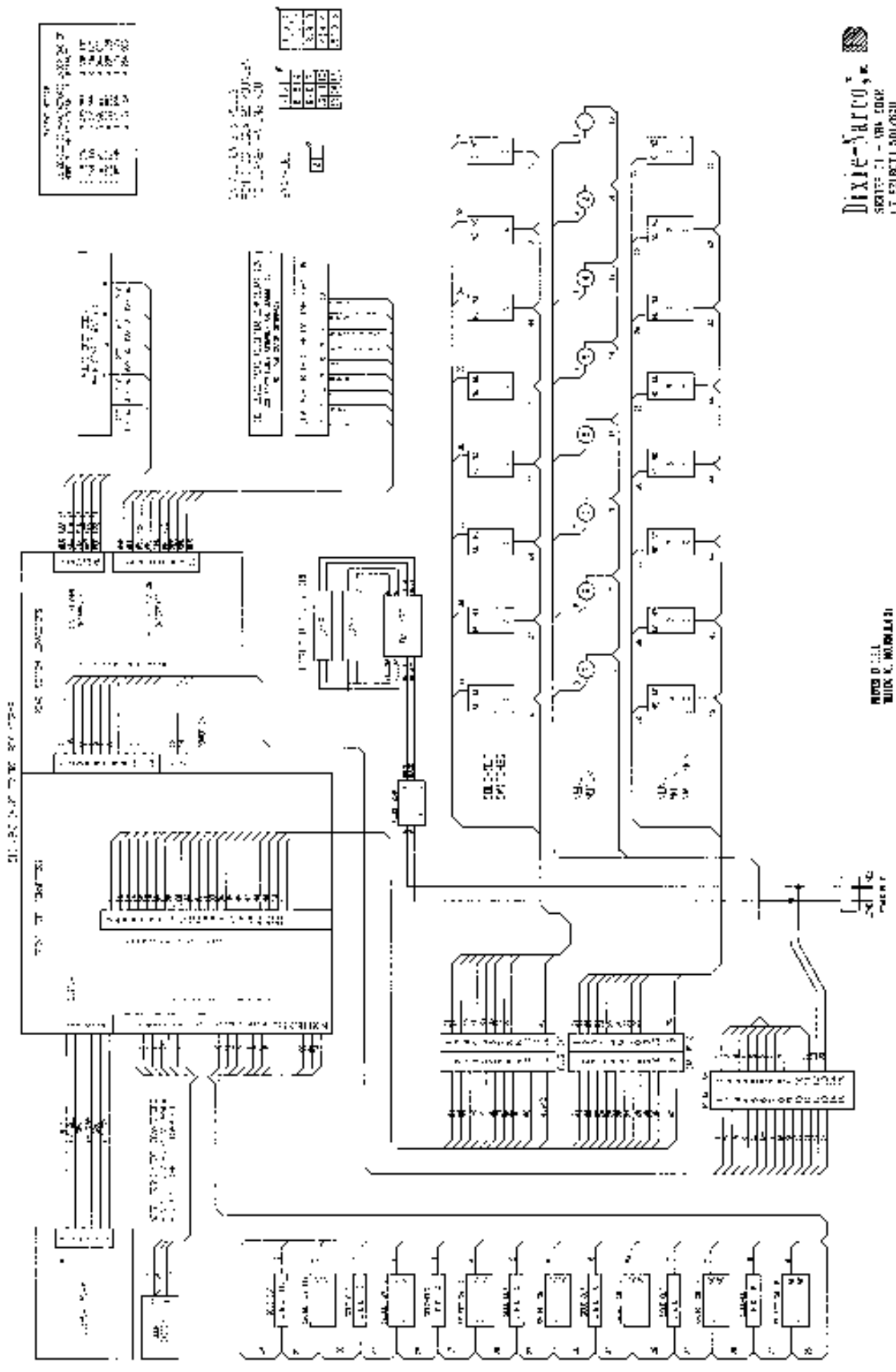

**Dixie-Vulco, Inc.**  
 SCHEMATIC - VRS COMP  
 17 FEBRUARY 1961/620

WATER BELL  
 WILSON K. WILSON JR.



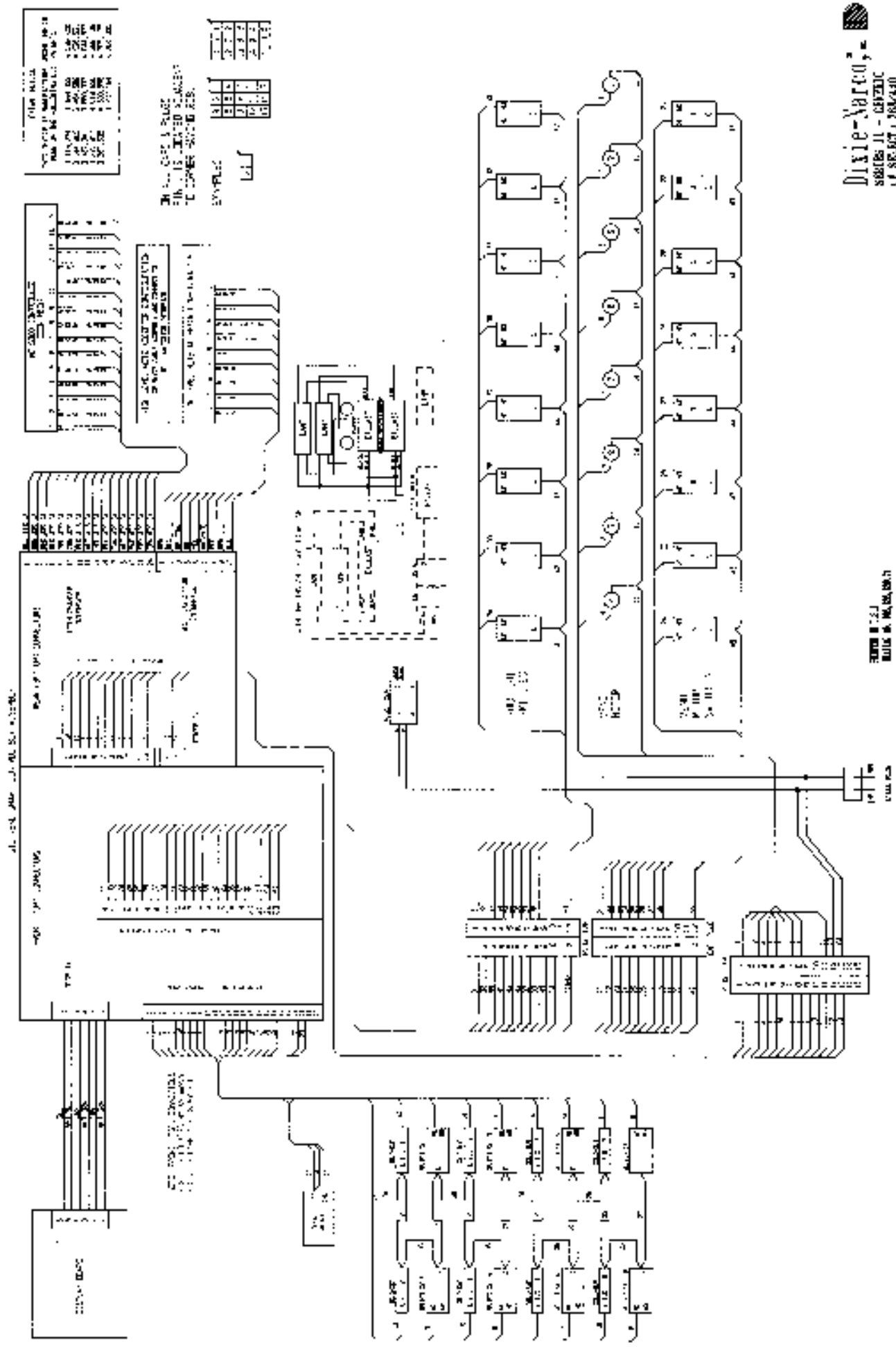

TABLE 1  
WIRING DIAGRAM FOR THE  
MOTOR CONTROL SYSTEM

1	2	3	4	5	6	7	8	9	10
11	12	13	14	15	16	17	18	19	20
21	22	23	24	25	26	27	28	29	30
31	32	33	34	35	36	37	38	39	40
41	42	43	44	45	46	47	48	49	50
51	52	53	54	55	56	57	58	59	60
61	62	63	64	65	66	67	68	69	70
71	72	73	74	75	76	77	78	79	80
81	82	83	84	85	86	87	88	89	90
91	92	93	94	95	96	97	98	99	100

IN THE CASE OF A  
FAILURE, THE SYSTEM  
WILL STOP AND  
RESTART AFTER  
A SHORT DELAY.

1	2	3	4	5	6	7	8	9	10
11	12	13	14	15	16	17	18	19	20
21	22	23	24	25	26	27	28	29	30
31	32	33	34	35	36	37	38	39	40
41	42	43	44	45	46	47	48	49	50
51	52	53	54	55	56	57	58	59	60
61	62	63	64	65	66	67	68	69	70
71	72	73	74	75	76	77	78	79	80
81	82	83	84	85	86	87	88	89	90
91	92	93	94	95	96	97	98	99	100

**Dixie-Varco**  
SERIES 11 - GENERIC  
(F 82.567) 289-440

FIGURE 1  
MOTOR CONTROL SYSTEM





21-104-0000 (A.M. R. 10000)

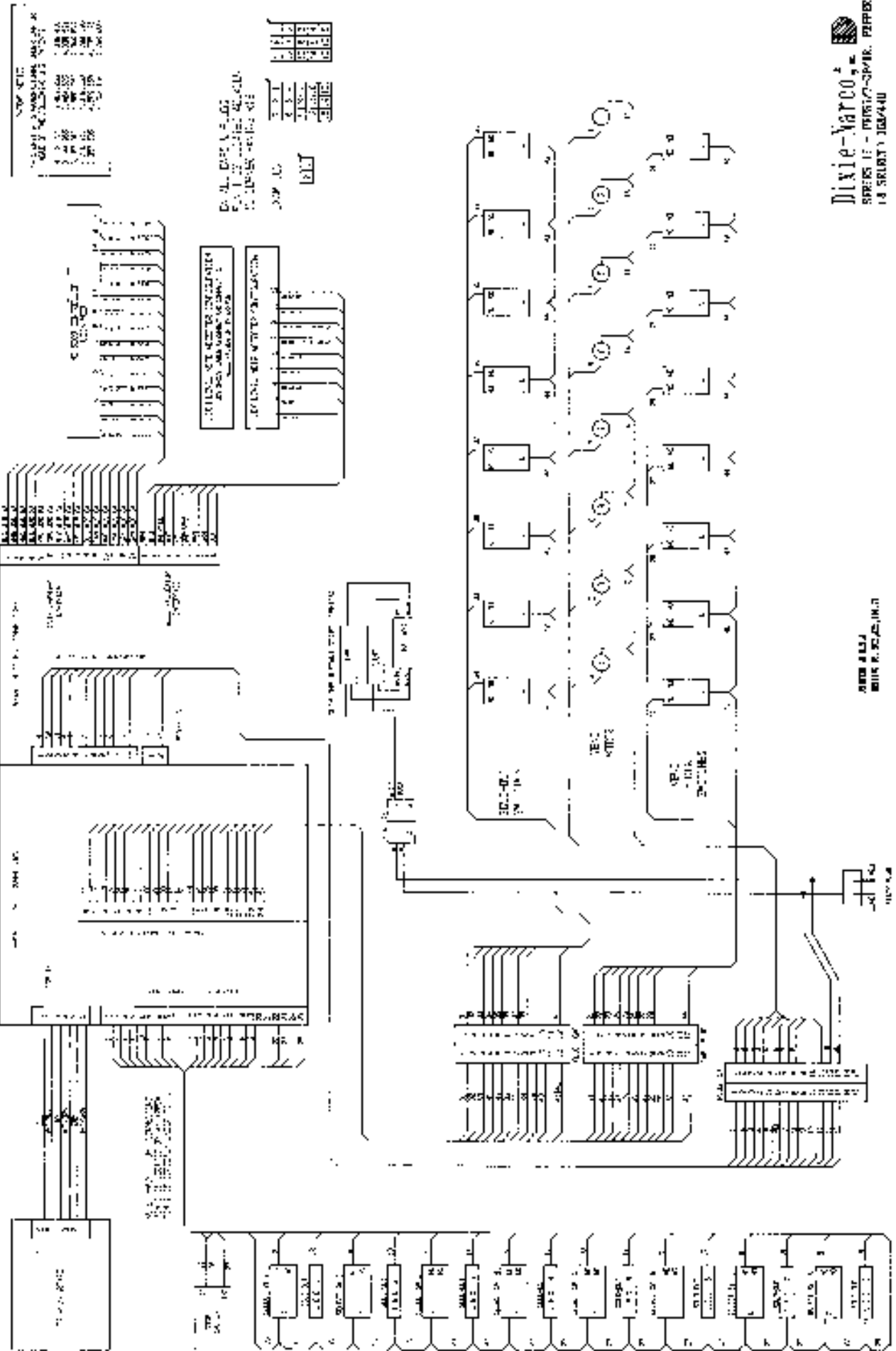

TABLE 1

1	2	3	4	5	6	7	8	9	10	11	12
1	2	3	4	5	6	7	8	9	10	11	12

TABLE 2

1	2	3	4	5	6	7	8	9	10	11	12
1	2	3	4	5	6	7	8	9	10	11	12

TABLE 3

1	2	3	4	5	6	7	8	9	10	11	12
1	2	3	4	5	6	7	8	9	10	11	12

NOTE: ALL RELAYS ARE OF THE 115V AC TYPE AND ARE TO BE INSTALLED IN THE CONTROL PANEL.

**Dixie-Varco**  
 SPEERS 11 - PRINTING-SHOP, PEPPER  
 18 SELWICK 100/440

ARMED 4/11/44  
 BUREAU OF INVESTIGATION





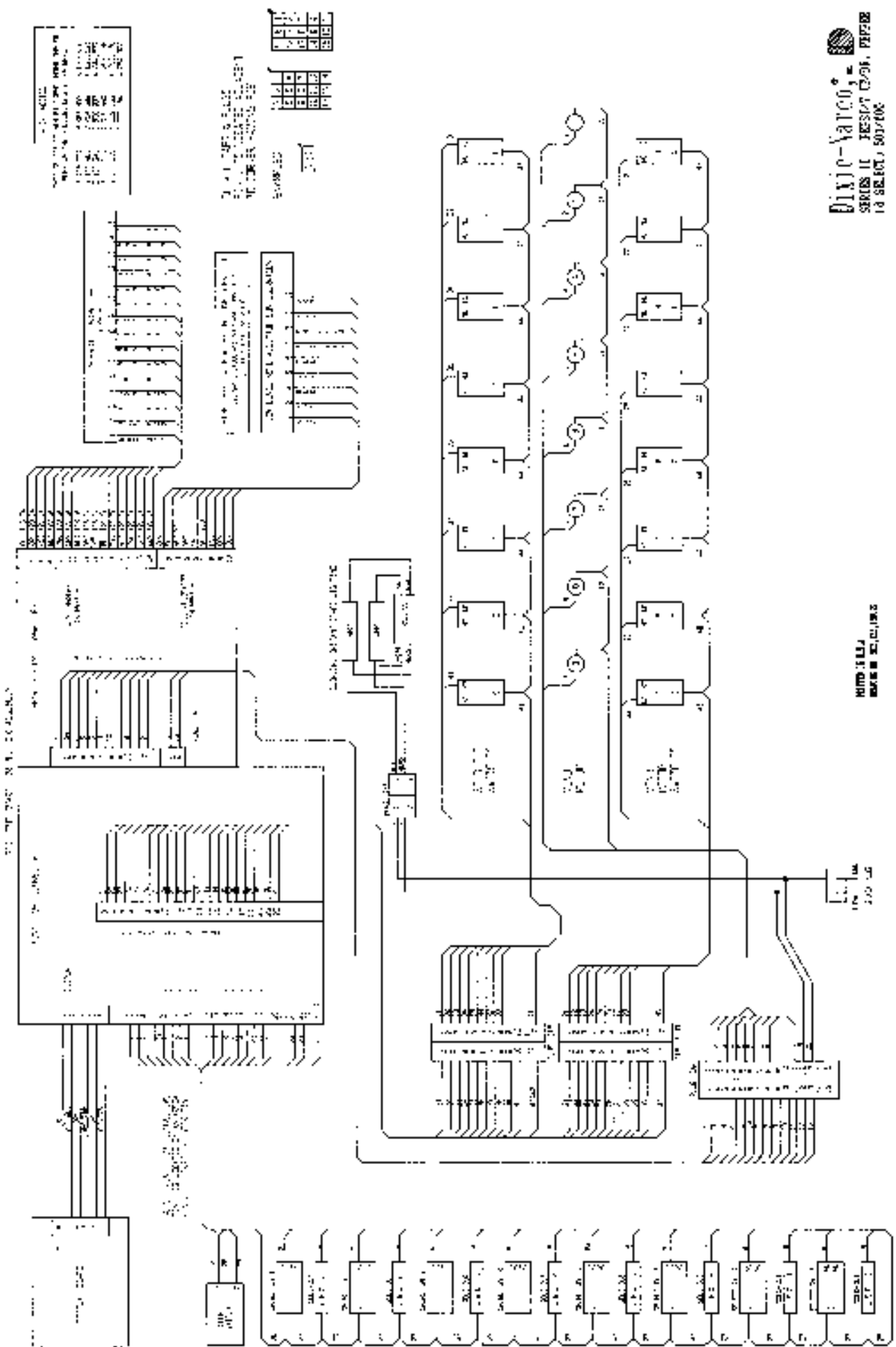

**Dixie-Varco, Inc.**  
 SERIES II TEST COOK. PAPER  
 10 SECT. 501700

WTD-1111  
 REVISED 12/12/52