

SNACKSHOP Model 4000
SNACKSHOP Model 4000
SNACKSHOP Model 4000
SNACKSHOP Model 4000
SNACKSHOP Model 4000

instruction manual for

SNACKSHOP Model 4000

AUTOMATIC



PRODUCTS

international, ltd.

75 WEST PLATO BOULEVARD • ST. PAUL, MINNESOTA 55107-2095

	Page
SCHEMATICii
WARRANTY	1
SPECIFICATIONS	1
CAPACITIES	2-3
UNPACKING	4
INSTALLATION	4-7
COMPONENTS	8
1. Power Supply	8
2. Changer	8
3. Mode Switch Box	8
4. Selection Panel and Control Board	8
5. Vend Motors	9
6. Price Checking Without M.I.S.	10
7. Management Information System	10-11
8. Price Setting Using M.I.S. and Product Code	11
9. Price Check Using M.I.S.	11
10. Cash Accountability.	11-12
11. Test Vend Mode Operation	12
12. Machine Identification Number	12
13. Service Diagnostic Display	12-13
14. Use of M.I.S.	13-14
15. Lighting System	14
16. Main Product Shelves	14
17. Delivery Bin	14-15
18. Coin Return	15
19. Coin Acceptance	15
20. Gum and Mint Mechanism	15
21. Gum and Mint Motors	15
22. Gum and Mint Empty Switches	15
23. Sliding Panel Removal and Installation	15
OPTIONAL EQUIPMENT	16
1. Ventilating Fan	16
2. Unification Kits	16
3. Gum and Mint	16
4. Special Spirals	16
5. Soup Dispenser	16
CLEANING	16
TROUBLESHOOTING	17
PARTS LIST	
1. Cabinet	22-23
2. Connectors	38
3. Delivery Bin	28
4. Door—Front Panels and Stylings	31-37
5. Door—Inside Front	20-21
6. Door—Outside Front	18-19
7. Electric Harnesses	30
8. Gum and Mint Panel	24-25
9. Main Button and Panel Assembly	29
10. Main Interlock Box	30
11. Product Shelves	26-27

This document is available free of charge to our customers at www.automaticproducts.com

MODE SWITCH BOARD

SELECTION SWITCH PANEL

MAIN PRODUCTS MOTORS SHOWING HARNESS CONNECTIONS

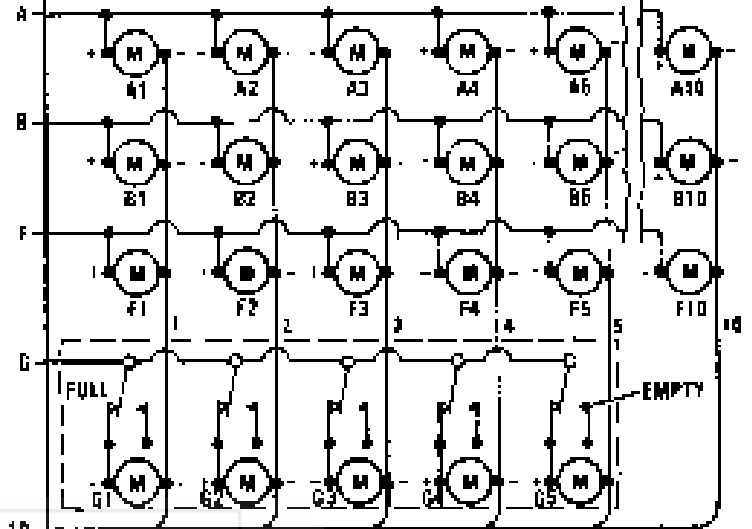

GUM & MINT DISPENSER

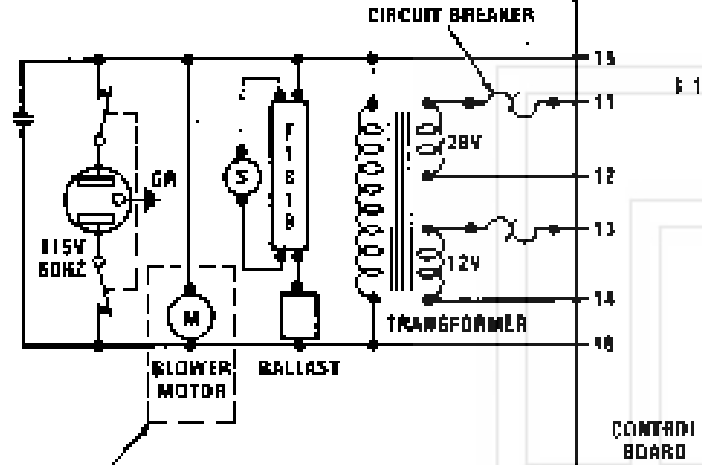
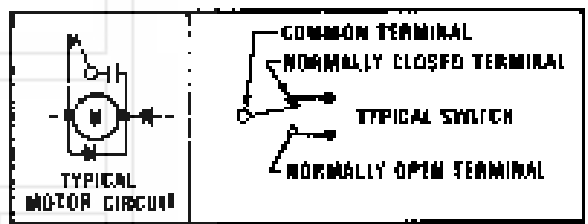

OPTIONAL EQUIPMENT INDICATED IN BROKEN LINE AREAS

18 PIN CHANGER SOCKET

LINE NUMBERS FROM CHANGER SOCKETS MATCH PIN NUMBERS ON SOCKETS

12 PIN CHANGER SOCKET

This document is available free of charge to our customers at www.automotiveproducts.com

WARRANTY

The Automatic Products Company warrants this vendor manufactured by it, to be free from defects in material or workmanship under normal use. Our obligation under this warranty is to the original purchaser only and is limited to making good at our factory any part or parts thereof which shall, within two (2) years after delivery of such product to the original purchaser, be returned to us or to our authorized dealer or distributor from whom purchased with all transportation charges prepaid to our factory, and which our examination shall disclose to our satisfaction to have been defective.

This warranty does not extend: 1: To any of our products which have been subjected to misuse, neglect, accident, incorrect wiring, improper installation, or to use in violation of instructions furnished by us; 2: To units which have been repaired or altered outside of our factory; 3: To cases where the serial number of the product has been removed, defaced or changed; 4: To electrical components, lamps, tubes or circuit breakers; 5: To accessories not of our own manufacture used with our products. Any part manufactured by Automatic Products Company, found by us to be defective within the warranty period will be exchanged by Automatic Products Company or their

authorized dealer or distributor without charge to the owner.

This warranty applies only to our products which are used within the United States of America, and is in lieu of all warranties expressed or implied, including, but not limited to, implied warranties of merchantability or fitness for a particular purpose, and no representative or person is authorized to assume for us any other liability in connection with the sale of our products.

The Automatic Products Company reserves the right to make any changes or improvements in its products without notice and without obligation, and without being required to make corresponding changes or improvements in products theretofore manufactured or sold.

AUTOMATIC PRODUCTS COMPANY
75 West Plato Boulevard
St. Paul, Minnesota 55107

Snackshop 4000 has been designed from superior engineering and with quality throughout. It has been built of rugged construction for many years of reliable trouble-free operation. Note: (For indoor use only)

To achieve the most economical trouble-free operation from your Snackshop 4000, it is recommended that this service manual be thoroughly read and instructions followed pertaining to all loading and servicing, etc., of the vendor.

Should you have questions pertaining to this manual or the vendor, please contact your local Automatic Products Company distributor or write directly to:

Service Manager
Automatic Products Company
75 West Plato Boulevard
St. Paul, Minnesota 55107

SPECIFICATIONS

HEIGHT — 72" WIDTH — 38.7/8" DEPTH — 35"
FLOOR SPACE REQUIRED — 9.5 SQ. FT.
SHIPPING CONTAINER SIZE — 72.5 CU. FT.
POWER REQUIREMENTS — 115 V., 60 HZ.
STANDBY AMPERES — .7 OPERATING AMPERES — 3

capacities

Unless otherwise specified, machine will be shipped with spiral assortment shown below.
 Figures in circles represent capacities in each spiral.

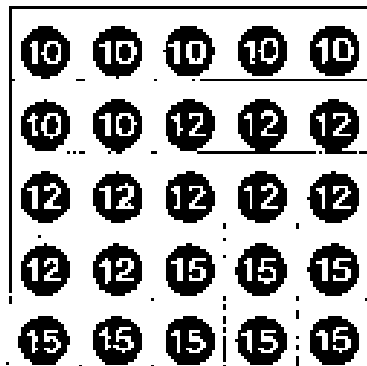

MODEL 4525
 Capacity as shown: 340 Units

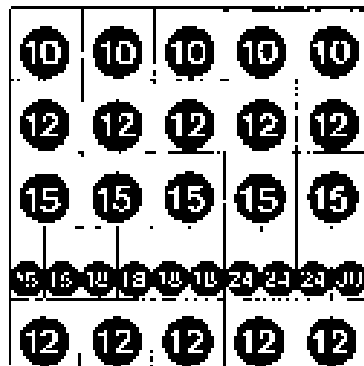

MODEL 4530
 Capacity as shown: 443 Units

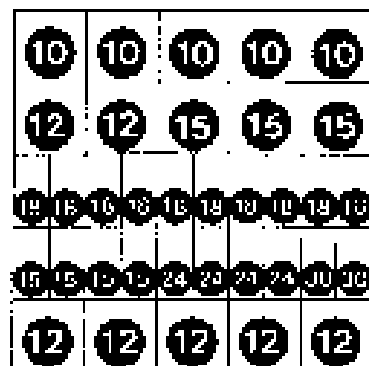

MODEL 4535
 Capacity as shown: 515 Units

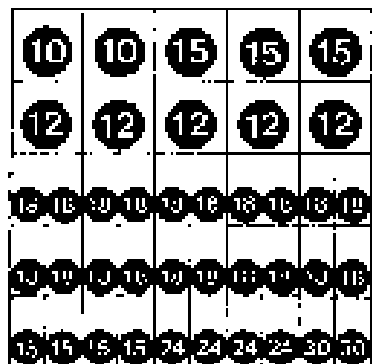

MODEL 4540
 Capacity as shown: 701 Units

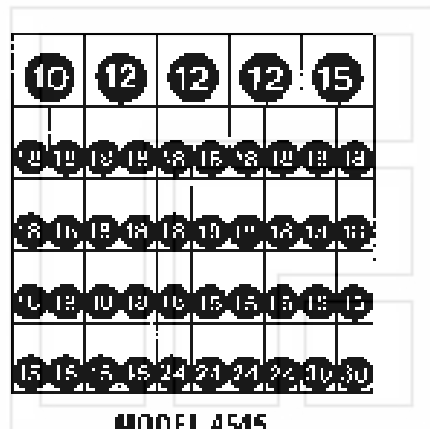

MODEL 4545
 Capacity as shown: 802 Units

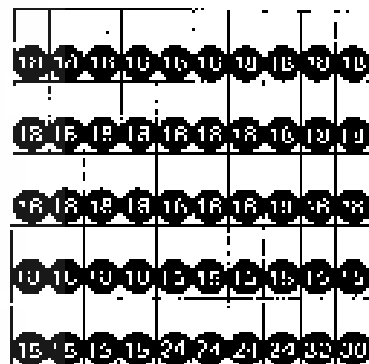

MODEL 4550
 Capacity as shown: 918 Units

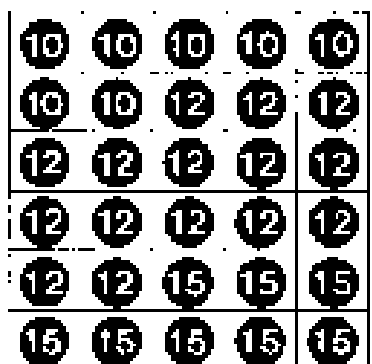

MODEL 4530
 Capacity as shown: 370 Units

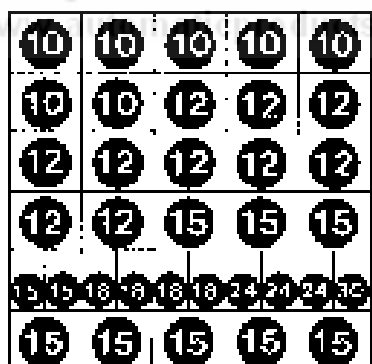

MODEL 4635
 Capacity as shown: 514 Units

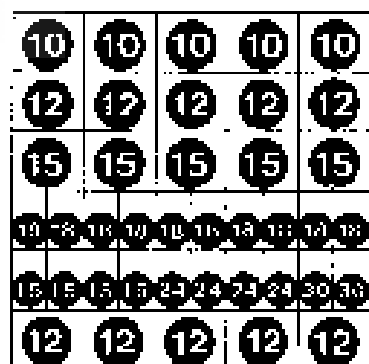

MODEL 4640
 Capacity as shown: 641 Units

This document is available free of charge to our customers at www.3m.com

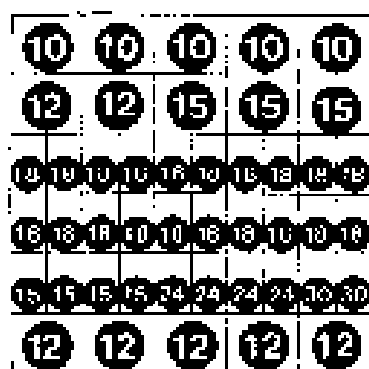

MODEL 4645
Capacity as shown: 755 Units

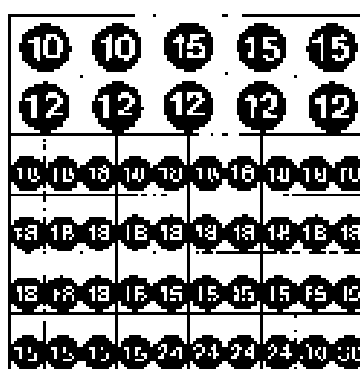

MODEL 4650
Capacity as shown: 863 Units

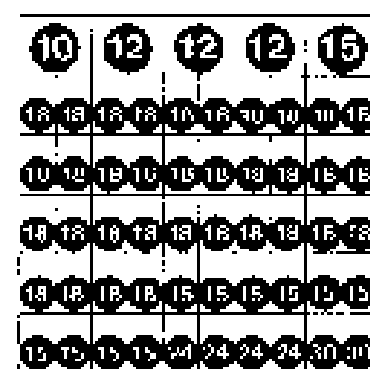

MODEL 4655
Capacity as shown: 979 Units

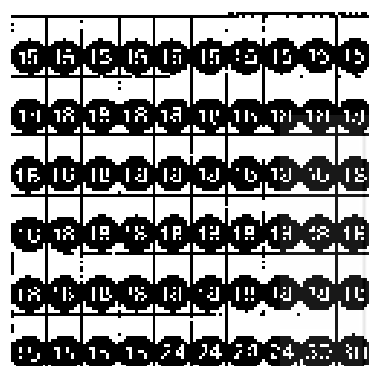

MODEL 4660
Capacity as shown: 1086 Units

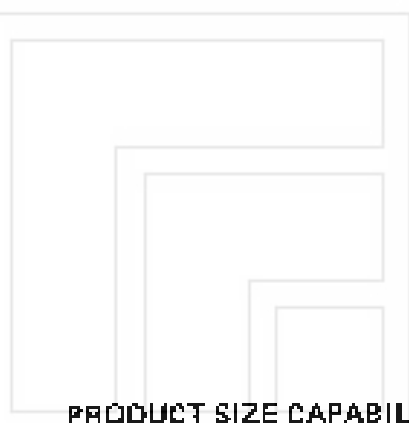

PRODUCT SIZE CAPABILITY

SHELVES	HEIGHT	WIDTH of Snack Shelves Only	WIDTH of Candy Shelves Only	DEPTH OF Snack Spools Only Choices:	DEPTH OF Candy Spirals Only Choices:
Top	9-1/4"	2 3/4" to 5 3/4"	1" to 2 3/4"		12 - Item Spiral 1-7/8"
Second	7 1/2"	2 3/4" to 5 3/4"	1" to 2 3/4"	7 - Item Spiral 2-1/2"	15 - Item Spiral 1-5/16"
Third	6-5/8"	2 3/4" to 5 3/4"	1" to 2 3/4"	10 - Item Spiral 2-1/16"	18 - Item Spiral 1-1/16"
Fourth	6 1/8"	2 3/4" to 5 3/4"	1" to 2 3/4"	12 - Item Spiral 1-11/16"	24 - Item Spiral 3/4"
Fifth	5-5/8"	2 3/4" to 5 3/4"	1" to 2 3/4"	15 - Item Spiral 1-5/16"	30 - Item Spiral 1/2"
Sixth	6-5/8"	2 3/4" to 5 3/4"	1" to 2 3/4"		

Can selection shelves for candy and other narrow items fit on all six positions.

Spiral of one item capacity can be freely interchanged with any other of the same diameter.

Baked items may need slightly larger clearances to vent properly.

Movable spacers available to adjust widths to ranges shown in each selection.

Gum and Mint Capacity. It is difficult to determine the true capacity due to variations of product size. The average capacity for the Gum and Mint stack is 175 items.

unpacking

The Snacktop 4000 is assembled and packed so that a minimum amount of time is necessary for preparation to install at an location. The following steps are recommended to insure correct unpacking:

1. **Shipping Damage:** Thoroughly inspect the exterior of the carton for damage which may have occurred during shipment. Report any damage to delivering carrier and follow their instructions.
2. Remove straps from lower edge and those at top of carton, and slit carton vertically at the taped corner. Open and remove carton. Remove the remainder of the packing material. On machines shipped with lock in place, the keys are stapled to the carton base.
3. **Remove Vendor With A Fork Lift Truck:** Remove the carton from the vendor. Open the door on the vendor and remove the hold down bracket at the front center of the cabinet base and close the vendor door. From the front of the vendor tip the vendor backward and lift force under the cabinet.
4. **Removing Vendor Without a Fork Lift Truck:** Remove the carton from the vendor. Remove all pieces of plywood located just behind the front legs, then open the door on the vendor and remove the hold down bracket at the front

center of the cabinet base and lift the vendor door. From the front of the vendor tip the vendor back far enough to clear the wood strip across the front of the base. Since the door toward the back until the legs separate the base and the base out.

NOTE: Because the weight concentration is toward the back of the cabinet, trucking and lifting should be done from the back. CAUTION should be taken when trucking from side.

5. On machines with lock in place, use six and 1/2" handle to open door. When no lock is furnished, remove lock handle retaining plate and 1/4" handle. Swing door to its full open position.
6. Remove all packing tape and paper from various areas of machine.
7. If the machine is equipped with a Gum & Mint unit, remove the shipping screw from the lower channel. Using the handle provided, pull panel out to its full extended position. Remove the shipping screw with rod leg attached located on the right side of the Gum & Mint Stack.
8. **Warranty:** The warranty card is attached to the cover of the manual. It must be filled out in full and mailed at once to insure coverage.

installation

1. **GENERAL:** In some locations, due to the size of this machine it is not possible to move the fully assembled machine through doors or narrow hallways. For such locations the door of this vendor can be removed, thus reducing the clearance required down to 32 inches.

DOOR REMOVAL: To remove the door, swing door to 90 degrees. Remove bolt and washer on door end of door stop. Remove screw and metal clamp. Disconnect the electrical harness from the door at the Control Board, two plugs and from the other two on plug light harness located at the lower pivot side of the cabinet door. Remove harness from the plastic clamps and fold it under the cabinet shelf. The upper hinge is secured to the cabinet by one bolt extending through the hinge from the inside of the cabinet. Use a 1/2" socket to remove. The lower hinge is secured to the cabinet by two bolts. These are located under the cabinet and are also used as leg mounting bolts. Remove only the two bolts, front and back, that go through the hinge on the left side of leg mounting plate. The other two bolts hold the leg in place. Do not remove them. Pull the door forward, the hinge plates will slide out of their guides, freeing the door. Remove left side panel extension which is held by four screws. Remove the cabinet to door filler assembly which is held in by twelve screws. To install the door, reverse the above procedure.

2. **LEVELING THE MACHINE** on location is important for the proper function of the machine. The four leveling screws in the legs are the means of leveling the machine. After positioning the machine, level machine in front to rear and right to left directions. After leveling, turn front right back set leveling screw in about one half turn to drop this corner slightly to make the door easier to close and lock.
3. **THE MAIN POWER CORD** is shipped fully inside the machine. Extend it through the hole located in the base on the left (hinge side) of the machine behind the transformer. Install the plate with key hole slots over the two screws in the base by the cone hole and drive screws tight to be secure in place.

In order to comply with electrical safety regulations and Underwriters Laboratories requirements, all electrical equipment must be properly polarized and grounded. The Snacktop 4000 is wired so that it is properly polarized in accordance with the electrical code. If the wall outlet is wired and grounded properly, then the vendor will connect properly.

Shown in View A & B are two properly grounded and polarized wall outlets. One is a three wire grounding type wall outlet (see View A) and one is a two wire wall outlet (see View B) with an adapter in place. To make a polarity check, use a 115 volt neon test lamp as shown on a volt ohm meter. The hot side of the circuit should always be counter clockwise from the ground terminal (which should be at the bottom).

Should the polarity at the wall outlet show any way other than that shown below, the outlet should be rewired.

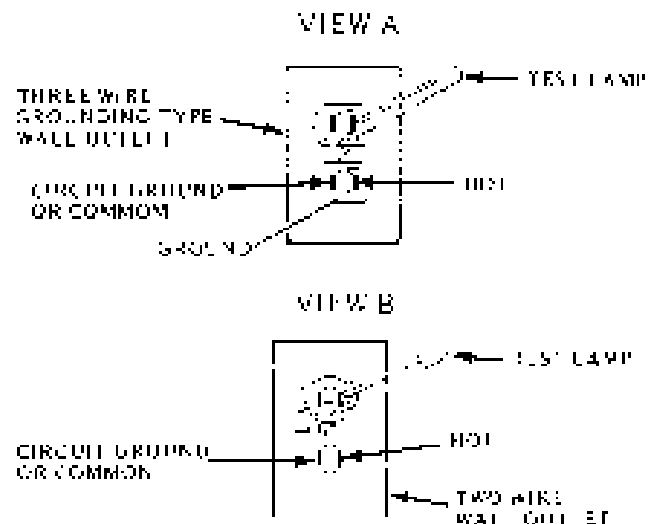

- LOADING SNACKS ON MAIN SHELF:** Open door to the proper position, push down on white plastic lock lever (Figure 1) on right side panel, the shelf to unlock the loading lever down. Grasp the shelf, raise both front corner ties (Figure 2) off from the front shelf, and gently lower main shelf ready to wrap. The wire is to be down for not need to make loading lever. Only one product size should be at the loading position at a time. When returning a shelf, be sure the shelf is in the home or send position. Begin loading with the top shelf. Move it to the loading position. The height spacing for items is greatest on this shelf and the latest, biggest items should be placed there. Soft items such as peanut bags, etc., should be placed on the lowest snack shelf, making the shelf distance as short as possible.

IMPORTANT: Product must not be forced into the spiral spaces but should fit freely. If the product is too tight, use a larger pitch spiral. The diameter of the product should be a centimeter less of the spiral wire that rests on the shelf surface (see Figure 2). The width of the product must be greater than the diameter of the snack spiral. If it is smaller, the product may fall through when in the proper front, ready to vend position.

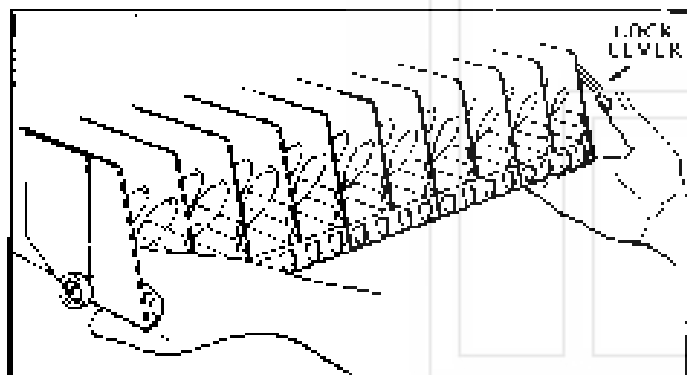

Figure 1. MOVING SHELF TO LOADING POSITION.

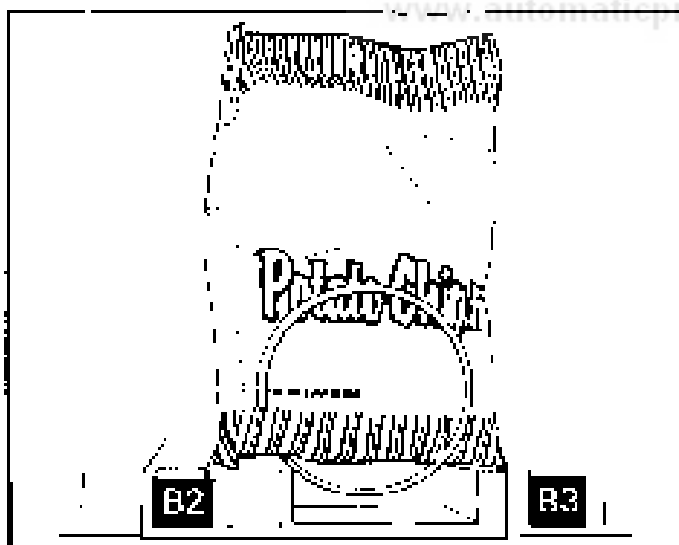

Figure 2. PLACEMENT OF PRODUCT ON MAIN PRODUCT SNACK SHELVES AND FRONT END POSITION OF SPIRAL.

- REMOVING OR INSTALLING:** To remove the spiral, grasp the spiral near the front of the shelf and pull forward. To install a spiral, align the hole in the cross shape at the rear of spiral with the motor shaft (see Figure 3). Be sure the front end of the spiral is positioned properly (with the front end of spiral pointing downward on the left side) (see Figure 2); slight drag between retainer tabs on spiral retainer (see Detail A, Figure 3) attached to motor shaft, push spiral to make the front tape snap over wrap (see Figure 3). Give a slight forward pull on front of spiral to check that it is locked in place.

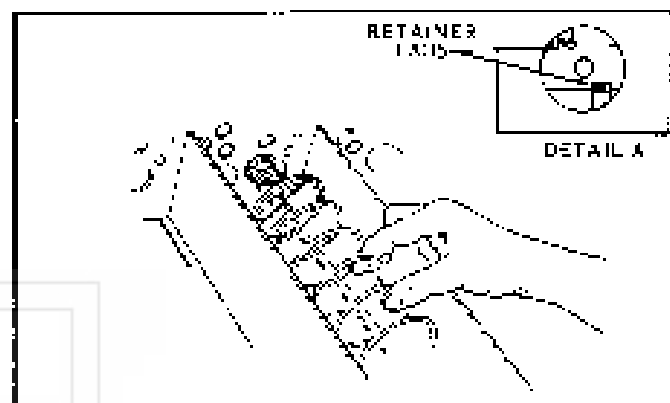

Figure 3. REMOVING AND INSTALLING SPIRAL.

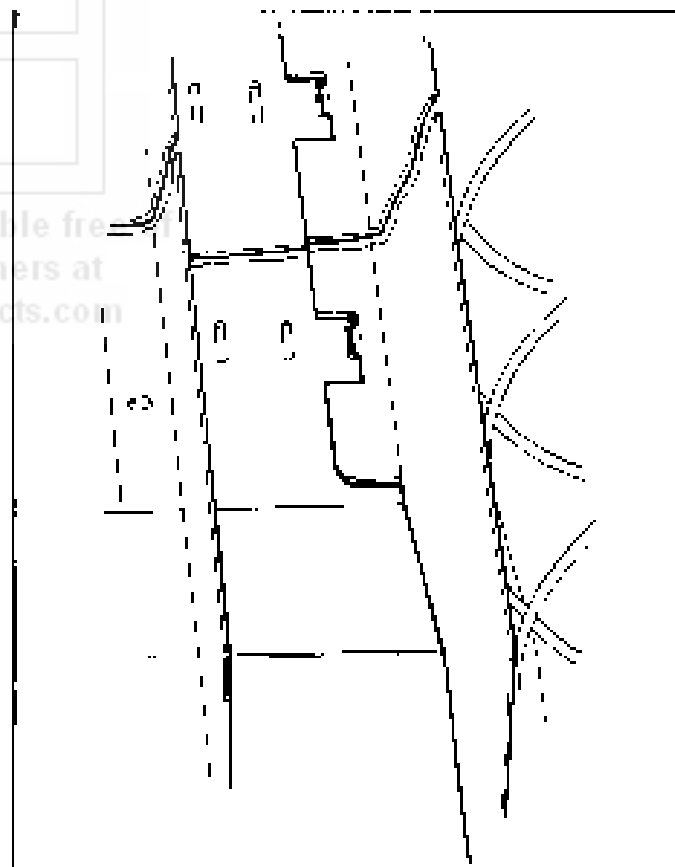

Figure 4. ALIGNMENT OF MOVEABLE PRODUCT SPACERS

installation

6. **PRODUCT SPACERS - 5 SELECTION SHELF:** A product spacer is used to reduce the width of the product area and should be used on any 5-selection snack shelf where the product width is $4\frac{1}{8}$ " or less. Spacers should fit within $\frac{1}{8}$ " of the product but should not fit tight against the product. There are three positions in each snack space where these spacers can be placed. To install the spacer, align the lock ears (on the lower edge of the spacer) with one of the three sets of slots (one front and one rear). (See Figure 4). Push the spacer to the rear to allow the ears to enter the slots, then allow the spacer to move forward. Be sure the ears are in the same set of slots, front and rear. (See Figure 4). Continue loading all spirals adjust with spacers where needed in the top shelf. Return the top shelf to the vend position and following this procedure load the remainder of the large spiral shelves. The shelf divider separating the right (lock side) column from the next column is movable to allow vending of products wider than $5\frac{1}{2}$ " in the second column. If this is used the right column must be used to vend a narrower product.
7. **LOADING MAIN PRODUCT CANDY SHELVES:** The 10-selection (candy type) shelves are loaded similar to the 5-selection shelves except that the bottom of the product sits on the shelf in front of the spiral wire (see Figure 5) that rests on the shelf. These products must also fit properly in the spiral space; do not force product into spiral.

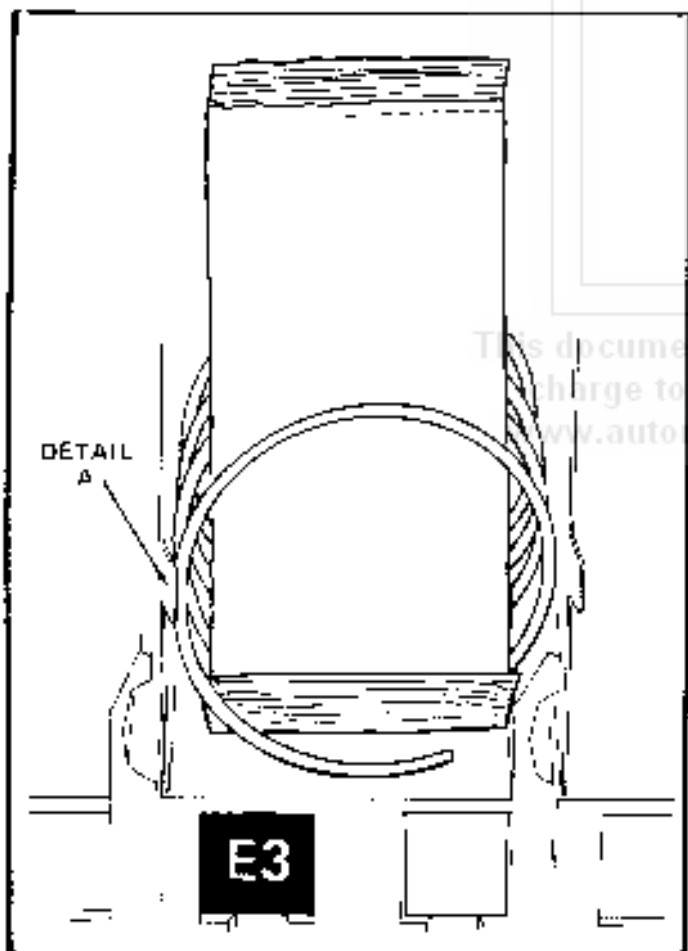

Figure 5. PLACEMENT OF PRODUCT ON MAIN PRODUCT CANDY SHELVES AND FRONT END POSITION OF SPIRAL.

These spacers are removed and installed the same as the large spiral (see Figure 5), except that the front end position is different (approximately 5 o'clock) (see Figure 5) and the front left side of the spiral must be behind the small tab located on the left side of the product space side wall (see Figure 5, Detail A).

8. **PRODUCT SPACERS - 10 SELECTION SHELF:** The 10-selection shelves are equipped with a product spacer (see Figure 6) that can be pivoted from the right side of each product space. These spacers should be pivoted out to hold the product upright, but not tight against the product. Leave about $\frac{1}{8}$ " clearance between the spacer and the product.

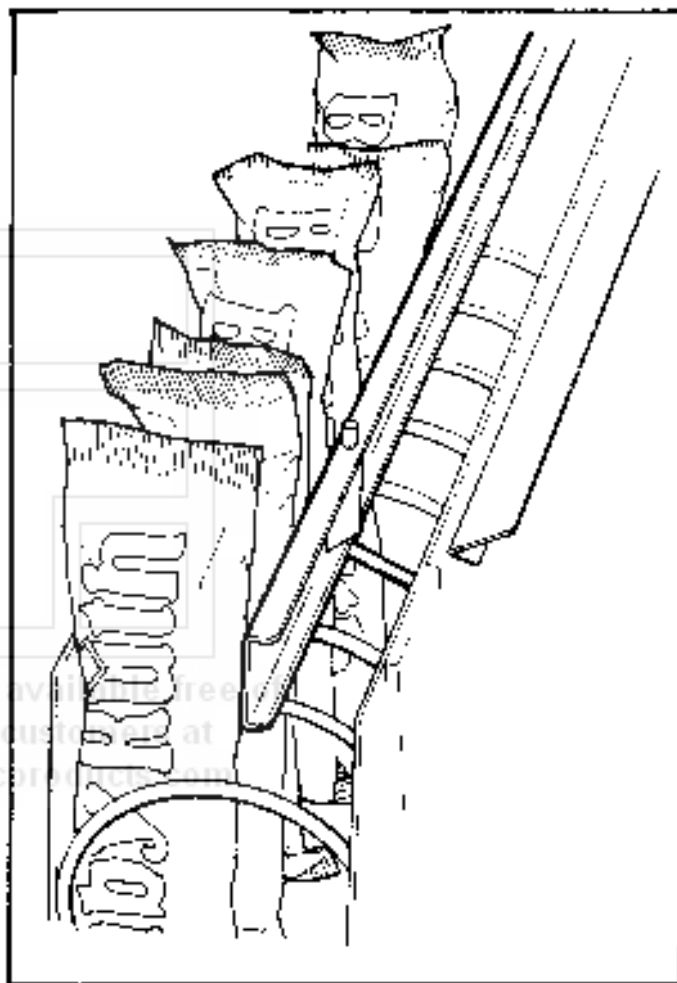

Figure 6. 10 SELECTION SHELF PRODUCT SPACER POSITIONED TO HOLD CANDY UPRIGHT.

9. **PRODUCT PUSHER:** The machine contains enough pushers for you to install a pusher on each candy spiral. This plastic part is designed to push the top of the product forward while it is vending, helping it fall from the shelf. It can also be used with products that have the wrapper end flap on the outside of the package. In this case, the pusher prevents these products from hanging on the spiral by spreading the flap. The pusher is installed approximately 210 degrees from the front end of the spiral with the tab extending forward (see Figure 7). Locate the pusher in its proper position, hold it against the spiral wire and push the semi-circular part around the spiral wire. Note: Not every selection spiral will need a product pusher. (Example—Six Items)

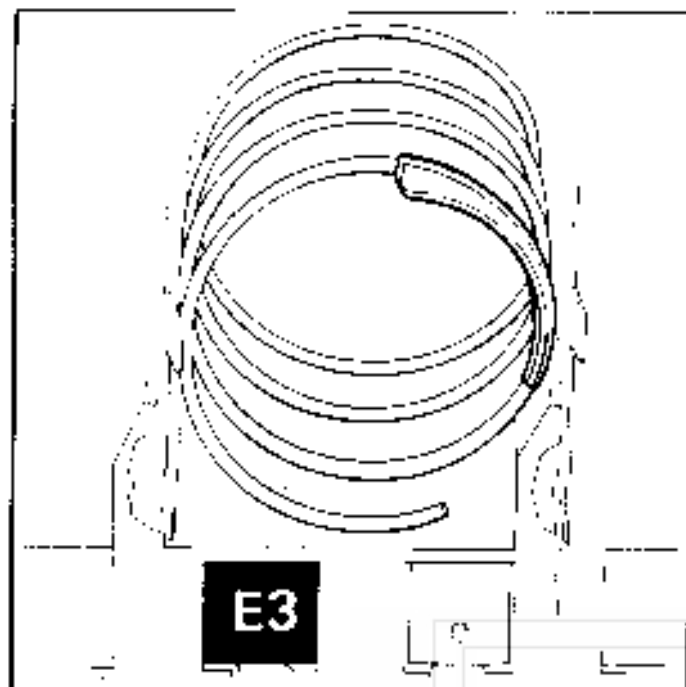

Figure 7. LOCATION OF PRODUCT PUSHER ON SPIRAL.



Figure 8. FOLD BAGGED ITEMS BOTTOM EDGE FORWARD AND UP.

10. BAGGED OR BOXED ITEMS in the 10-selection shelves if not loaded properly could be a problem. The sealed edge of the bag may get under the spiral wire causing the product to hang up after it has been vended. It is recommended that the lower edge of these types of product be folded forward and up (see Figure 8) next to the product before inserting into the spiral space.
11. CIGARETTE VENDING FROM SNACKSHOP 4000: Cigarettes can be vended from the candy shelves using the (7.5 capacity) spiral for the soft pack regular, king, 100mm or (20mm) packs. The (12 capacity) spiral should be used for (box) packs.
12. LOCK PRODUCT SHELVES. After all the product has been loaded be sure all shelves are returned to their vend position behind the front roller guide.
13. INSTALL PROPER PRICE TABS into price tab holder for each selection in the main product area. (See Figure 9.)
14. LOADING GUM-AND-MINT: The Gum-and-Mint columns and drive mechanism are located on the sliding panel. Pull out the sliding panel. Unlatch the Gum-and-Mint stack and lower it to the loading position. Any of the columns will vend vend-pack gum or short mints. All of the columns have fillers which may be removed to vend long mints. When reinserting these fillers into the stack be certain the "dimples" of the fillers are in the holes of the stack. One column has a small mint filler. This filler must be removed to vend gum or regular size mints. Retainers are attached to the base of each column. An instruction decal is positioned on the back of the Gum-and-Mint stack showing the proper use of retainers and fillers. After the columns have been loaded, return the Gum-and-Mint stack to its up and loaded position. Remove the Gum-and-Mint display box from the door and fill it with the correct product.

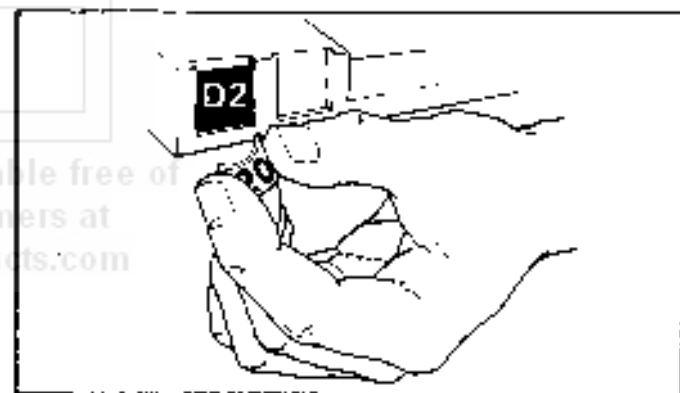

Figure 9. INSTALLING PRICE TABS.

15. INSTALL PRICE TABS and product into the display box and replace display box on to the door.

INTRODUCTION

The Snackshop 4000 represents a new concept in vending. There are no timing switches, vend relays or individual selection switches. All of the machine functions are managed by a Control Board located on the inside of the door. The Control Board operates much like a computer. In addition to controlling normal machine functions the Control Board has a memory and micro processor for the incorporation of an M.I.S. (Management Information System). M.I.S. was designed to give the operator an accurate and up-to-date view of product movement through the machine (product inventories, cash inventories, service time, etc.). Although M.I.S. is an invaluable tool for the operator, it is not necessary for normal machine operation. The following instructions deal with the functioning and set-up operations of the machine with and without the use of M.I.S. Read the instructions from beginning to end to get a complete understanding of all machine functions and the interrelationship of components.

1. POWER SUPPLY

The 115V, AC, power cord plugs into the switch and circuit breaker box located below the shelf toward the hinge side. All connections from the transformer, lights, fan (not used) and to the machine connect on the hinge side of this box. All connections are different so you cannot get them plugged wrong. The transformer supplies two output voltages: 28 VAC and 12.6 VAC. These voltages pass through the circuit breakers located above and below the power switch. The green leads from the transformer are 28 VAC and the red leads are 12.6 VAC. The 28 VAC and 12.6 VAC go only to the Control Board. The voltage used on the vend motors and switches is 24 VDC. **DO NOT** test motors with AC and be sure polarity is correct or damage will result. When removing or installing any component be sure the power is off. If the Control Board has to be removed, take special care. **DO NOT** lay the board on a metal surface.

CAUTION Do not short battery lines as an explosion could result.

2. CHANGER

The changer is to be mounted on the changer mounting bracket located on the gum and mint sliding panel. Remove the changer hold down screw which has been installed in this bracket for shipment. Hang the changer on the shoulder studs provided. Re-install the hold down screw to lock the changer in place. After securing the changer to the changer mounting bracket, plug the changer into one of the two receptacles located below the gum and mint stack. The changer plug will determine which receptacle should be used. Be sure the changer cord is clear of the coin return lever operation. Load change into the payout tubes and turn the power switch on.

3. MODE SWITCH BOX

The mode switch box is located on the door above the changer. It allows for control of the following machine functions: Operate mode, set price mode, check price mode, test vend mode, service mode and set serial number mode (see Figure 10).

IMPORTANT: When operating the machine in any mode other than the operate mode, the door must be open. The machine is automatically put in the operate mode when ever the door is closed.

NOTE: Before closing the door push the operate button to home any motors which may be out of position.

- A. **Operate Mode**—Normal machine operation featuring total control of door mechanism operation and accountability.
- B. **Set Price Mode**—Used to program each selection with a price and/or product code.
- C. **Check Price Mode**—Used to check prices and/or product codes of programmed selections.
- D. **Test Vend Mode**—Allows normal machine operation as in the "operate" mode except management data is recorded separately from data recorded in the operate mode.
- E. **Service Mode**—Indicates the operational condition of all L.E.D. displays and vend motors.
- F. **Set Serial Number Mode**—Machine identification number for M.I.S. accountability.

4. SELECTION PANEL & CONTROL BOARD

The selection panel (Figure 11) on the Snackshop 4000 incorporates the use of a self enclosed membrane switch panel. This eliminates the need for individual switches and wiring. The membrane switch panel is housed in a stainless steel panel with individual buttons protecting the switch face. The stainless steel front also houses the instruction and digital display glass (Figure 12). Included on the instruction glass are three messages for customer instruction when the machine can not complete a vend for an item selected (Figure 12). If this condition occurs, an audible signal is given to the customer and an L.E.D. next to the proper instruction will flash until the customer takes further actions at

Removal of the selection panel:

First, turn the power off in the machine. Disconnect all the plugs on the control board. Remove the four shoulder screws (Page 29, Item 23) holding the control board cover. Remove the four nuts (Page 29, Item 24) and the control board. Remove the two board spacer locks (Page 29, Item 18) and the four board spacers (Page 29, Item 26). Next, remove the door coin chute (Page 29, Item 21) and the two nuts above this chute. (**NOTE:** The coin return assembly does not have to be removed.) Reattach the selection panel and trim by reversing the above procedure.

This document is a
charge to our customers at
Automatic Vending

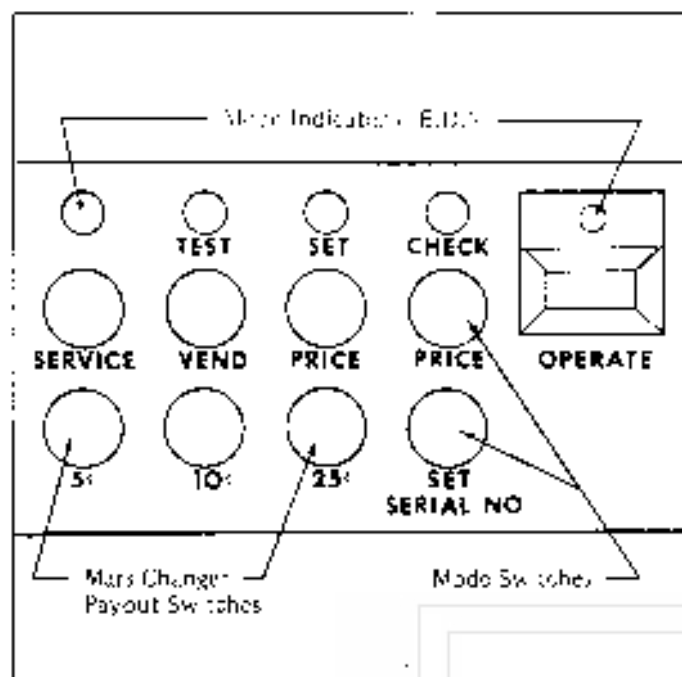

Figure 10. MODE SWITCHES.

5. VEND MOTORS

The Snackshop 4000 incorporates the use of a high RPM DC Motor. The new DC Motor has an 85% greater starting torque over the Snackshop 4000/500 AC Motor, yet weighs only 40% of the AC Motors weight. Due to the new design, the vend motor may no longer be moved by hand. **DO NOT TRY TO TURN THE SPIRALS BY HAND. DAMAGE TO THE MOTOR WILL RESULT.** Any necessary timing will be done by the machine. It is also important to check polarity before applying current to the motor. Two diodes and a capacitor are used to prevent circuit feedback and may have to be checked when trouble shooting motor problems.

PRICE SETTING WITHOUT USING M.I.S.

Pricing is done through the selection panel in conjunction with the mode switch box.

A. Press the "set price" button on the mode switch box (Figure 10). The L.F.D. above the set price button will light and the product code display located on the selection panel will be explained later. Any selection programmed at this reading will be removed from the operating program. This would be used when shelves are moved or the number of selections changed to remove those selections not present in the machine from the program.

B. Press button "1" on the selection panel and the display will show "00.00" (Figure 14). This is the price display and can be incremented up by pressing button "1" and down by pressing button "12". Increments are 5¢. **CAUTION:** Any selection programmed at "00.00" will free vend.

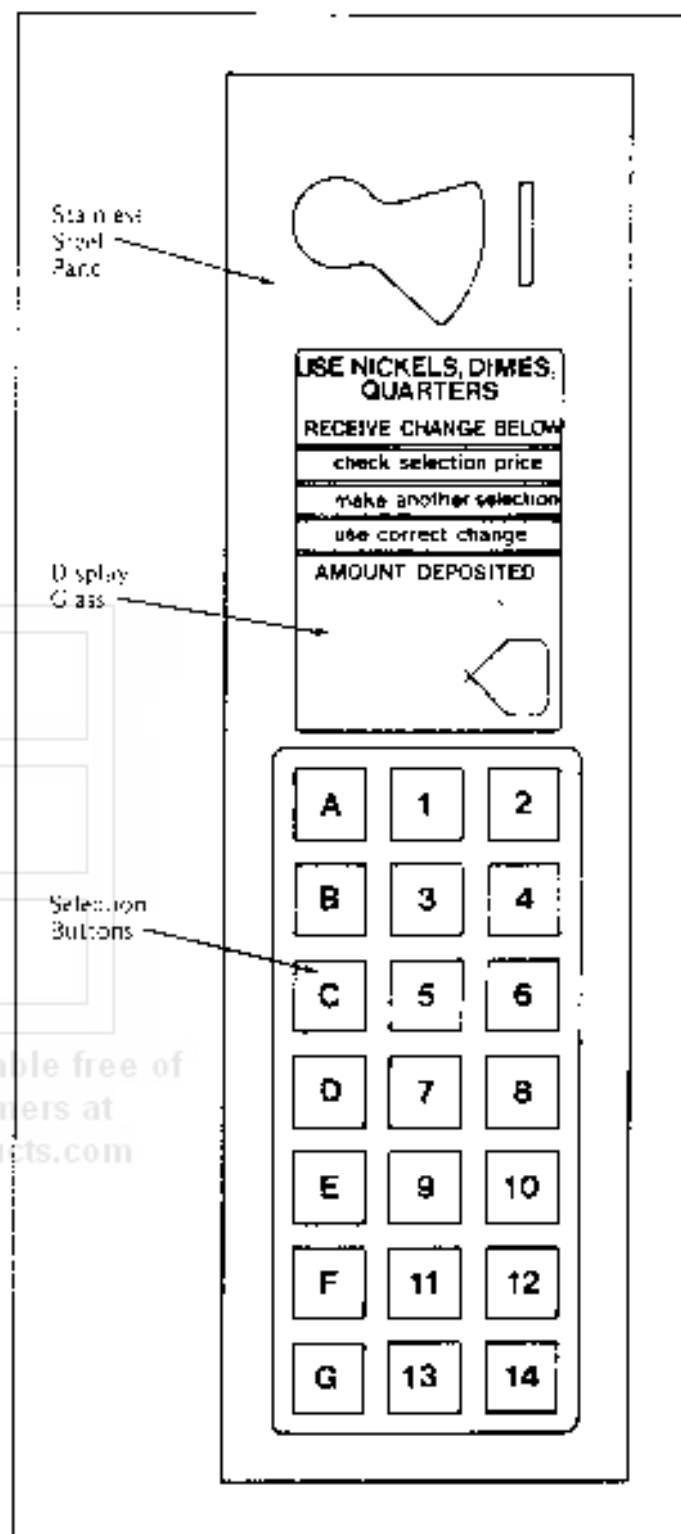

Figure 11. SELECTION PANEL

C. With the selling price displayed, press first the letter, then the number for each selection to be sold at that price. Increment to your next price and enter those selections. Repeat until all selections have been programmed with their proper price and product code.

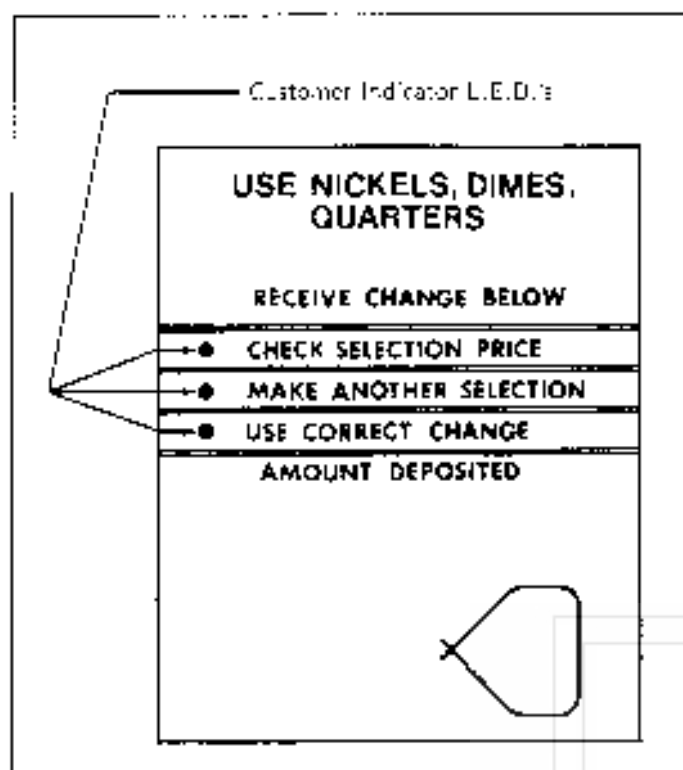

Figure 12 INSTRUCTION AND DIGITAL DISPLAY GLASS.

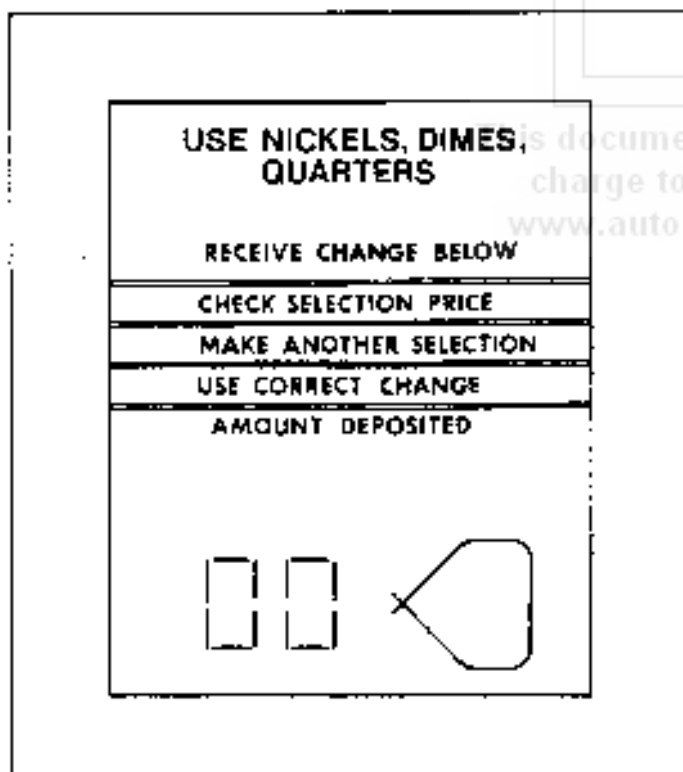

Figure 13.

6. PRICE CHECKING WITHOUT USING M.I.S.

After all prices have been programmed, they should be checked to verify that each selection has been programmed correctly.

- A. Press the "check price" button on the mode switch box (Figure 10). The L.E.D. above the check price button will light and the selection panel display will be blank.
- B. Press the letter and then the number for the first selection to be checked. The price display will show the price that selection is programmed for (Figure 15). Check the displayed price against the price tab on the shelf for that selection.
- C. Continue to check prices until all selections have been checked. Follow "Price Setting Without Using M.I.S." instructions to correct any errors found.

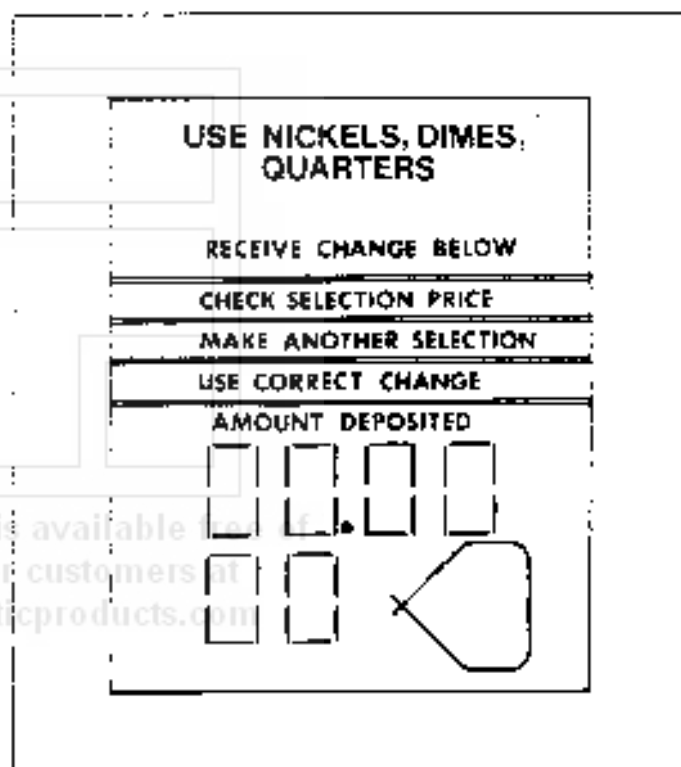

Figure 14.

7. MANAGEMENT INFORMATION SYSTEM (M.I.S.)

The Snackshop 4000 is equipped with the data collecting capabilities and the hardware to function as part of the Management Information System. When you are using the M.I.S., the price setting and price checking require the use of a product code. This gives the operator the versatility to use the product codes in any way to best fit his operation.

A product code is a number (00 through 64), used to identify a specific product or group of products. The product code need only be used when M.I.S. is being used. The product code gives the operator total amount of individual product sales or product group sales.

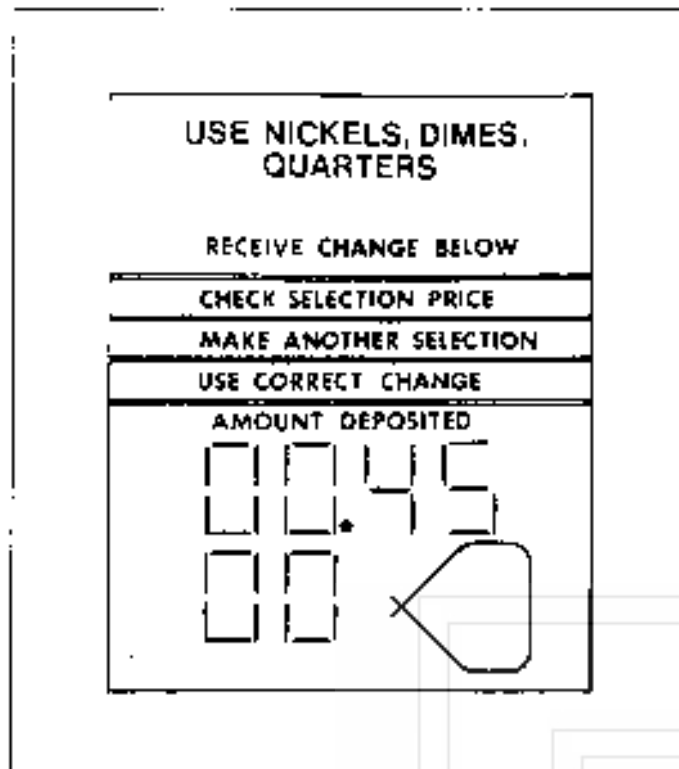

Figure 15. SHOWING A SELECTION PROGRAMMED FOR 45¢

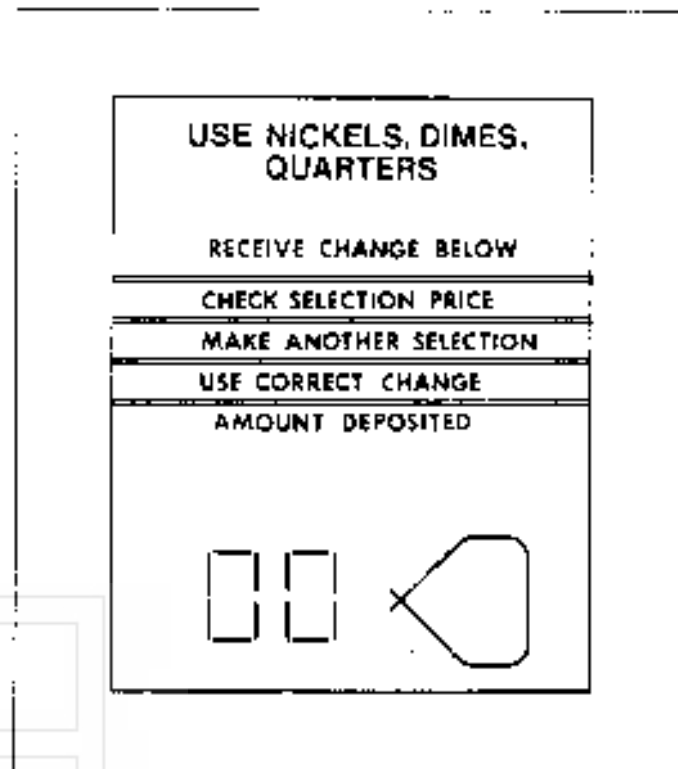

Figure 16.

The M.I.S. records by product code, the number of vends and total dollar amount vended for each product code programmed. This gives the operator the versatility to program a product code for each selection in the machine or one product code for all selections within the machine.

Increment to your next price and/or product code and enter those selections. Repeat until all selections have been programmed with their proper price and product code.

8. PRICE SETTING USING M.I.S. AND PRODUCT CODE

Pricing is done through the selection panel in conjunction with the mode switch box.

- A. Press the "set price" button on the mode switch box (Figure 10). The L.E.D. above the set price button will light and the display located on the selection panel will show "00" (Figure 16). This two digit display is the product code and can be incremented up by pressing button 13 and down by pressing button 14. Increments are one. Any selection programmed at this reading will be removed from the operating program. This would be used when shelves are moved or the number of selections changed to remove those selections not present in the machine from the program.
- B. Press button 11 on the selection panel and the display will show "00.00" (Figure 17). This is the price display and can be incremented up by pressing button 11 and down by pressing button 12. Increments are 5¢. **CAUTION:** Any selection programmed at "00.00" will free vend.
- C. With the product code and selling price displayed, press first the letter, then the number for each selection to be sold at that price and product code.

9. PRICE CHECK USING M.I.S.

After all prices and/or product codes have been programmed, they should be checked to insure that each selection has been programmed correctly.

- A. Press the "check price" button on the mode switch box (Figure 10). The L.E.D. above the check price button will light and the selection panel display will be blank.
- B. Press the letter and then the number for the first selection to be checked. The display will show the price and product code that selection is programmed for (Figure 15). Check the displayed price against the price tab on the shell for that selection.
- C. Continue to check prices and product codes until all selections have been checked. Follow "Price Setting Using M.I.S." instructions to correct any errors found.

10. CASH ACCOUNTABILITY DISPLAY

A running total of dollars vended by the machine may be displayed on the selection panel display without the use of the M.I.S. This total may not be changed by anyone and represents an accurate cash accountability meter.

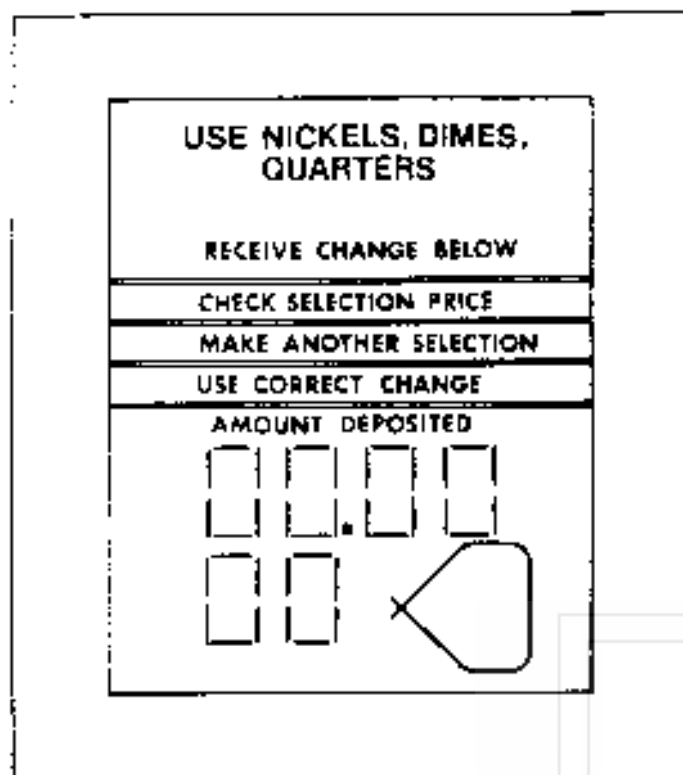

Figure 17.

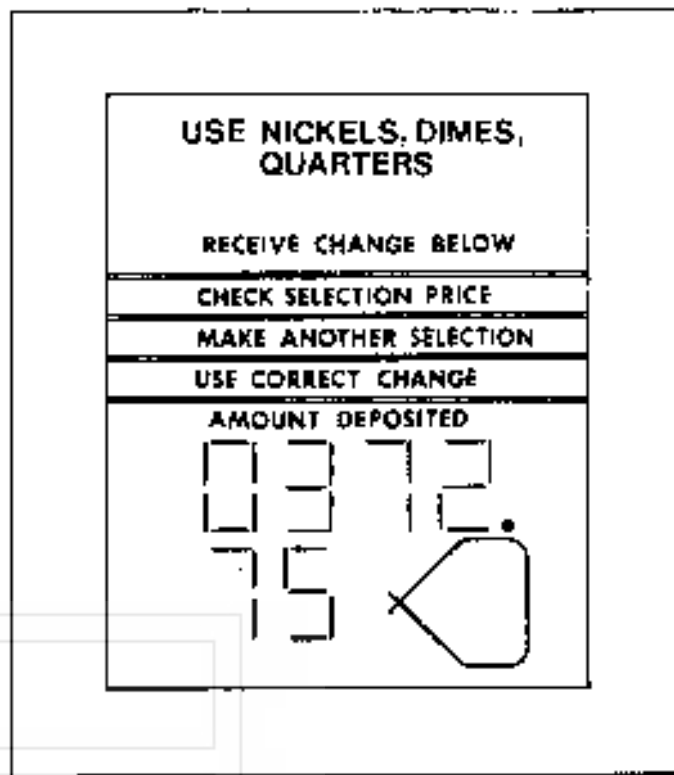

Figure 18. SHOWING \$372.75

- A. Press the "check price" button on the mode switch box (Figure 10). The L.E.D. above the check price button will light.
- H. Press button 14 on the selection panel and the total dollars vendcd by the machine will be displayed (Figure 18).

11. TEST VEND MODE OPERATION

The test vend mode was incorporated in the Snackshop 4000 to allow machine servicing and testing without affecting the management data or cash accountability of customer vends and customer dollars received. When M.I.S. is not used, the test vend mode prevents service and test vends from being included in the cash accountability readout. When M.I.S. is being used, the test vend mode records the number of vends and dollar amounts received in a separate category from that same information which is recorded in the operate mode. This gives the operator total control over all product amounts sold and dollar amounts within the machine.

- A. Press the "test vend" button on the mode switch box (Figure 10). The L.E.D. above the test vend button will light and the display located on the selection panel will be blank. The machine is now ready to operate exactly under the same conditions as in the operate mode, so you will have to use money for the testing. After all servicing and testing has been made return the machine to the operate mode. The machine is now ready for normal customer usage.

12. MACHINE IDENTIFICATION NUMBER FOR USE WITH M.I.S.

When using the M.I.S. each machine must have an identification number.

- A. Remove the hole plug located on the mode switch box above the words "set serial no.". The set serial number switch will be located beneath the hole plug.
- B. Press the set serial number mode switch. The old serial number (if there is one) will be displayed on the selection panel.
- C. Enter the new number by pressing the panel number button; Button #10 equals 0 (Figure 19).

13. SERVICE DIAGNOSTIC DISPLAY

Incorporated in the Snackshop 4000 series machine is an automatic circuit check. When the machine is engaged in the "operate" mode a scan is made to check the operating condition of all selection motors. Any non-functional motors are recorded and can be displayed for trouble shooting corrections.

- A. Press the "service" button located on the mode switch box (Figure 10). The L.E.D. above the service mode button will light and the selection panel L.E.D.'s will all light (Figure 20). This tells the service person if all L.E.D.'s are in operating condition and that the Control Board is operating.

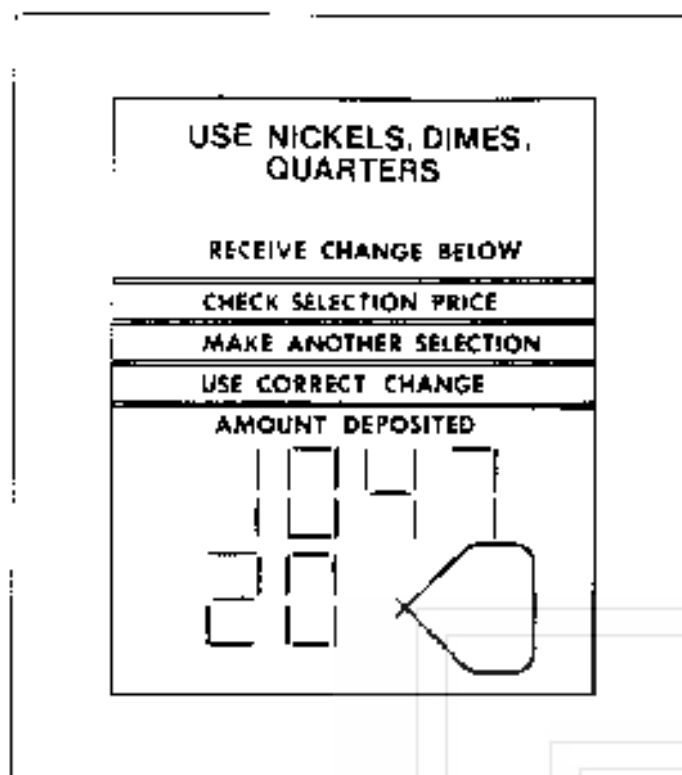

Figure 19. SHOWING A SERIAL NUMBER OF 104720

14. USE OF M.I.S.

The Snackshop 4000, as stated earlier, is equipped to gather information on an M.I.S. Lister and Mars or Colman data retrieval unit can be used. Refer to Figure 42 for data retrieval hook up location. The following data is given out by the Snackshop 4000:

- A. Serial number for machine identification.
- B. Total dollars vendod for all products sold.
- C. Total cash to the cash box (Mars changer only).
- D. Total number of interrogations or information readouts.
- E. The last four door openings greater than five minutes apart.
- F. Total test vendod cash.*
- G. Total test vend cash in the cash box (Mars changer only).*
- H. Total number of test vendis.**
- I. Total number of customer vendis per products code.**
- J. Total vend cash per product code.**

*Test vendis and test vendod cash refers to vendis made and cash accepted by the machine when it is in the test vend mode. This allows the route person to make test vendis without affecting the accountability of customer vendis and cash.

- B. Press button 14 on the selection panel. If any of the motors are not functioning (jammed, bad switch, bad harness, etc.) the first non-functioning motor in the series will be displayed on the selection panel display (Figure 21).
- C. If a non-functioning motor exists, record the selection on paper and repeat step B. Continue this procedure until all non-functioning selections have been displayed, recorded and the selection panel display reads all 8's (Figure 20).
- D. If all motors are operational the selection panel display will read all 8's.
- L. Inspect and repair the selections recorded from the service diagnostic display.
- I. After servicing the non-functioning selections return all shelves to a vend position and press the "operate" button located on the mode switch box. A slight delay will occur before the operate L.E.D. will light. This delay is the machine making the automatic circuit scan. At the time the scan is taking place any motors not in the start position automatically are cycled. **DO NOT TRY TO TURN THE SPIRALS BY HAND. DAMAGE TO THE MOTOR WILL RESULT.**
- G. To insure that all serviced selections are operational, repeat steps A and B.

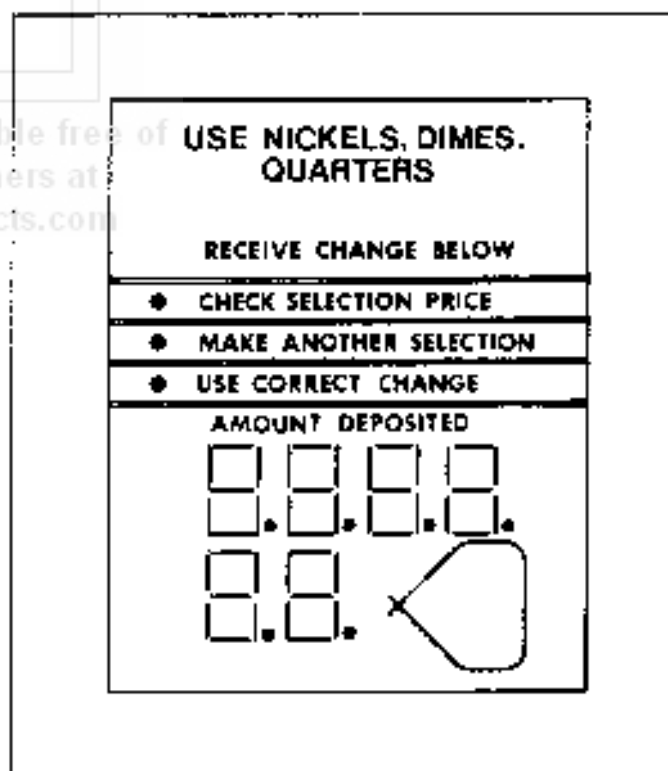

Figure 20.

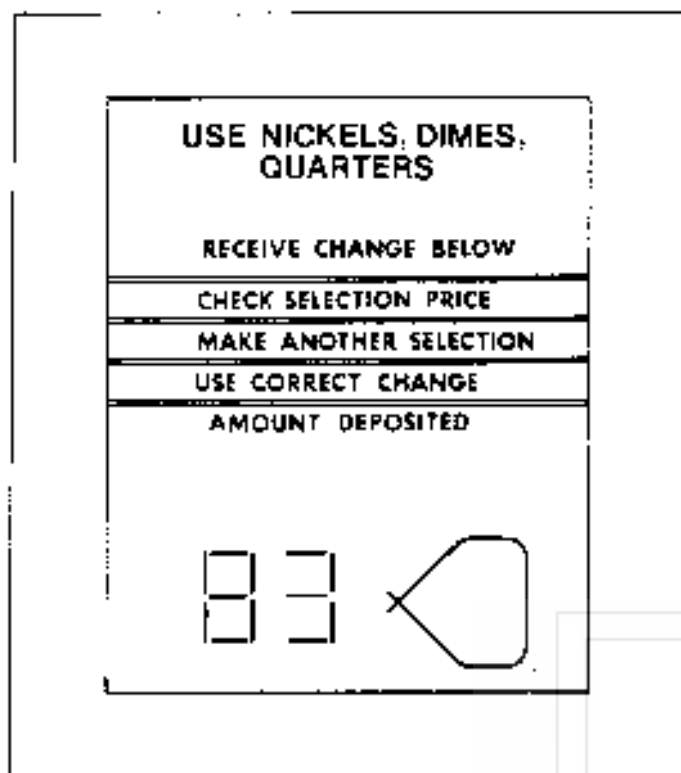

Figure 21. SHOWING SELECTION B3 NOT OPERATING

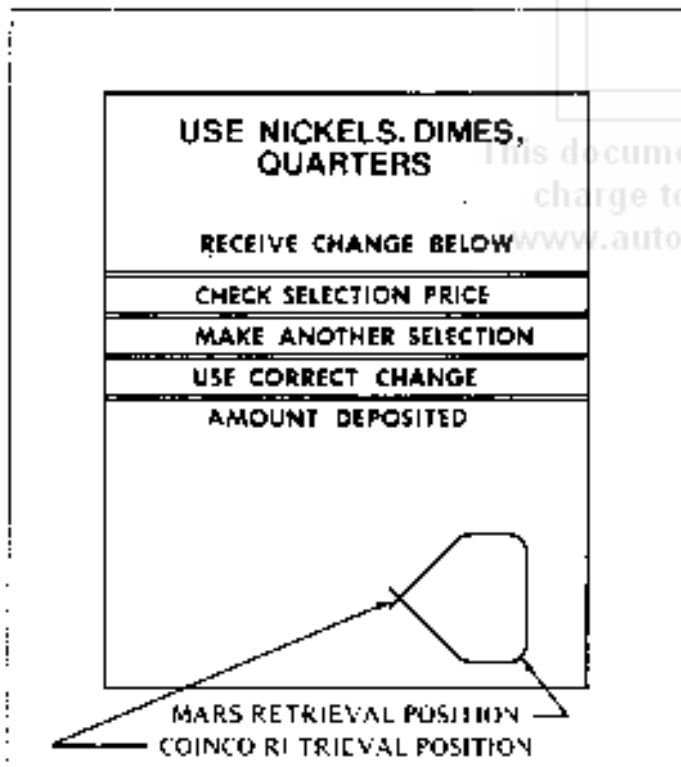

Figure 22.

**Customer vendors refer to normal customer usage when the machine is in the operate mode.

The interrogator or data probe is a hand held device used to withdraw the information recorded by the M.I.S. for analysis. Two devices are available: One device withdraws the information through a magnetic coil while the other uses light sensors. The Snackshop 4000 is equipped to handle either device.

15. LIGHTING SYSTEM:

There is only one fluorescent lamp in the Snackshop 4000. The lamp is located in the top of the door, and lights the main product area and the product sign, if used. The starter is located on the hinge side of the lamp. The ballast for the circuit is located on a bracket on the lower pivot side of the cabinet.

16. MAIN PRODUCT SHELVES:

There are five or six main product shelves per machine. Each shelf carries either five or ten selections. Each selection has its own motor and motor hold switch mounted to the back of the shelf. Every shelf has its own harness and plug for connecting to the remainder of the circuit through the cabinet receptacle, located in the rear center of the cabinet. The motors and switches are the same on either type shelf. It is now possible in the Snackshop 4000 to exchange a five selection shelf with a ten selection shelf or visa versa. NOTE: When exchanging the shelves, you will not need any parts, but you will have to reprogram the machines for prices and selections.

REMOVAL OF PRODUCT SHELF:

- A. Lift up and push the lock lever toward the back of cabinet. See Figure 1.
- B. Pull the shelf to its loading position.
- C. Grasp shelf in front and rear center. Lift front of shelf up above horizontal and pull shelf forward while lifting.
- D. To install shelf, reverse above procedure.

17. DELIVERY BIN:

This is located below the display window on the door and is mechanically operated. The linkage on the outside ends of the delivery bin may require occasional lubrication. Should the door become difficult to operate, place a small amount of grease on the arm tracks.

REMOVAL OF DELIVERY BIN:

- A. Remove the screws from the underside of the delivery bin. These screws fasten into the lower door brace and remove the two screws and brackets at the top of the delivery bin.
- B. Grasp delivery bin on both sides and lift up and pull back. Should bin be tight, rock it by lifting on one end, then the other.

REPLACEMENT OF DELIVERY BIN:

- A. Locate lip on front edge of delivery bin over lower edge of opening in door and panel trim. Press down along lip to make sure it is fully engaged between door and trim.

8. Tighten the four screws and two brackets, to secure the ejector.

18. COIN RETURN:

The coin return lever, located on the door and the coin return linkage located inside the changer, scavenges the slug rejector. Actuation of the coin return lever will clear the rejector of any damaged coins and will also cancel all credit on the changer, returning that amount to the customer.

19. COIN ACCEPTANCE:

A coin or coins (e.g. 10¢ or 25¢ coin) being deposited pass into the rejector and into their respective coin baths in the changer establishing the credit. The coins then enter either the self-rod change tubes on the changer or the coin box. Actuation of the coin return lever prior to making a selection will cancel all credit on the changer and will return the amount of deposit back to the customer.

20. GUM AND MINT MECHANISM:

The Gum and Mint mechanism is located on the sliding panel. It consists of the Gum and Mint stack, which contains five individual columns. The motor mounting bracket under the Gum and Mint stack contains the five (5) individual vend motors, one for each column. Each motor has a switch mounted to it and a clutch assembly.

OPERATION:

When a Gum and Mint selector button is pressed the selected switch will energize the respective motor for that selection. Once the motor has started for a vend, it will complete a cycle as long as the Gum and Mint empty switch is being made. In the event there is only one product left in a column the Gum and Mint empty switch will not be made allowing to light and beep the L.E.D. display (make another selection) on the door.

NOTE: All ejectors should be in the inward position.

Should a product jam in the Gum and Mint mechanism the clutch assembly is designed to allow the motor to clutch past and return it to its standby position keeping the vendor operative even though a Gum and Mint selection is jammed. Once a jam occurs in the Gum and Mint unit, it will be necessary to re clutch the Gum and Mint ejector to put it back in cycle. To do this clear the jammed product, set up a credit and press the selector button for the column where the jam occurred, then when the ejector moves to the inward position or standby position, hold the ejector by hand and allow the motor to re clutch. Test cycle several times to assure proper operation.

21. REMOVING GUM AND MINT MOTORS AND/OR EJECTORS:

The Gum and Mint Motors are mounted to a motor mounting bracket mounted underneath the Gum and Mint Stack. To replace a motor or an ejector, lower the Gum and Mint stack and remove the three screws securing the motor mounting bracket to the stack. At the same time pivot the motor mounting bracket down and return the Gum and Mint Stack to the latched position. The motors and ejectors are now accessible to be removed.

To reinstall the motors pivot the motor mounting bracket upward making sure that the clutch head cranks (Item #15, Page 24) slip into the ejector properly. Then lower the Gum and Mint Stack and replace the three screws.

22. GUM AND MINT EMPTY SWITCHES

Behind the Gum and Mint stack, mounted to the sliding panel is a series of five switches. When a Gum or Mint selector button is pressed, these switches either allow the selection to be vend if the column has product, or light and beep the L.E.D. lamp on the door (Make another selection) if that column is empty.

23. REMOVAL OF SLIDING PANEL:

The entire sliding panel can be removed from the machine by using the following procedure:

- A. Pull panel to its full position.
- B. Disconnect (5 Pin) plug to the left of the G&M stack.
- C. Remove the receptacle mounting bracket and lay down the harness in the machine.
- D. Remove panel stop bracket located on upper side of roller channel assembly. This bracket is located about 6" from the front edge of cabinet at the top.
- E. Grasp the panel to support its weight and pull forward and lift upward. Be careful that the roller channel does not fall off panel.

REPLACEMENT OF SLIDING PANEL:

- A. Engage lower edge of panel in lower track while still supporting panel. Be sure that nylon guide rivets are in place at back of panel (2 rivets) and front of guide track (2 rivets).
- B. Guide roller channel onto upper track and lift and push panel and channel into cabinet.
- C. Reinstall stop bracket. Bracket must be installed in back of channel in top of cabinet, as this bracket is what stops the sliding panel in its forward position.
- D. Plug in the 6 pin plug from the cabinet harness.
- E. Replace the receptacle mounting bracket and the harness to the sliding panel.
- F. Push panel back into cabinet.

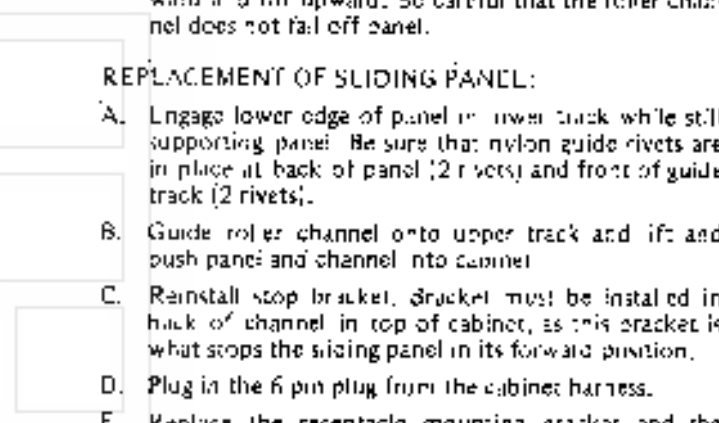

This document is available for customers at products.com

optional equipment

1. VENTILATING FAN: (Kit #750782)

The ventilating fan operates on 115 volts and keeps a steady flow of fresh air moving through the vendor cabinet.

Installation of the ventilating blower takes but a few minutes and requires no additional wiring; all the vendors are wired with a plug for the fan. Installation instructions are sent with the kit.

2. UNIFICATION KITS.

Unification kits are available to make the vendor compatible with other manufacturers.

3. GUM-AND-MINT.

Gum and Mint units are available as an option with Snack-shop 4000 vendors.

For information pertaining to loading or servicing gum-and-mint unit, refer to this service manual for loading instructions and for service instructions.

4. SPECIAL SPIRALS.

Special candy spirals are available for use in the five (5) selection snack shelves. For the sake of identification, the back end of these spirals are painted RED and should never be used in the ten (10) selection candy shelves.

These spirals allow vending products that are too wide for the standard candy columns but may be too thin for the regular snack spirals. A product pusher and spacer would be used where required. Part numbers for these special spirals are as follows:

600254	24 space special spiral
600254-1	18 space special spiral
600254-2	15 space special spiral
600254-3	12 space special spiral
600254-4	30 space special spiral

NOTE: The difference between the standard candy spiral and the special candy spiral used in the wide snack columns is in the overall length of the spiral. The special spiral is shorter than the standard candy spirals.

CAUTION: Do not attempt to use the special candy spirals in a ten (10) selection shelf.

5. SOUP DISPENSER: (Kit 750083)

A canned soup dispenser is available as an option for use in the five selection snack shelves. The dispenser is easy to install and holds up to nine cans in the unit.

cleaning

The Snack-shop 4000 will do the best merchandising job for you if it is kept clean. The display window can be cleaned with any good glass cleaner. The exterior and interior surfaces should be cleaned with warm water and mild detergent. Rinse thoroughly and dry all surfaces.

CAUTION:

Do not use any cleaners containing silicon as this could cause electrical failures.

The main product shelves can be best cleaned with the spirals and product spacers removed. Refer to page 5 for removal of spirals and page 6 for removal of the product spacer. There are openings in each end of the delivery bin at the back for cleaning out dirt.

The gum and mint chute should be removed and cleaned once a month. This chute is located on the gum and mint panel side of the right side panel. Pull the gum and mint panel to its full forward position. The chute requires no tools for removal, it is a friction fit behind the front flange of the right side panel. Grasp under the chute, lift up about one inch, then move chute to rear of machine to disengage it from panel flange. Move chute to right and bring forward under gum and mint carriage housing. Reverse above procedure to reinstall chute.

Clean the acceptance on the changer frequently as accumulated dirt in this area can cause coins to hang or not be accepted. Follow recommended cleaning procedures as described by the manufacturer.

TROUBLE	CAUSE	REMEDY
Motor runs 1/2 the turnst.	<ol style="list-style-type: none"> 1. Capacitor discharging current. 2. Defective motor or control board. 3. Loose wire on motor. 	<ol style="list-style-type: none"> 1. Resolder capacitor or replace motor. 2. Replace motor or control board. 3. Replace wire.
Motors appear defective		<ol style="list-style-type: none"> 1. Check for 18 volts from transformer to control board.
Spirals turn continuously.	<ol style="list-style-type: none"> 1. Defective control board. 	<ol style="list-style-type: none"> 1. Replace board.
Motors run on same number throughout machine A1, B1, C1, D1, E1, F1.	<ol style="list-style-type: none"> 1. One of the motor wires is shorting out. 	<ol style="list-style-type: none"> 1. Check each individual motor for loose or pinched wire and replace it.
Cannot set prices in machine.	<ol style="list-style-type: none"> 1. Defective selection switch. 2. Defective control board. 	<ol style="list-style-type: none"> 1. Replace selection switch. 2. Replace board.
Push A & A1 turns. Push B & B1 turns.	<ol style="list-style-type: none"> 1. Selector switches shorting out. 	<ol style="list-style-type: none"> 1. Replace selector switch assembly
No L.E.D. lights on mode box.	<ol style="list-style-type: none"> 1. Plug on interlock box is unplugged or on the mode box. 2. Defective control board. 3. Mode switch box not plugged correctly. 	<ol style="list-style-type: none"> 1. Plug in. 2. Replace board. 3. Check both ends of harness
Press the service mode but cannot empty changer.	<ol style="list-style-type: none"> 1. Plug on the mode box is not plugged in right. 2. Check the 2 lower plugs on the control board. 3. Defective changer. 	<ol style="list-style-type: none"> 1. Plug in. 2. Plug in. 3. Replace changer.
L.E.D. stays on operate mode.	<ol style="list-style-type: none"> 1. Mode box defective. 	<ol style="list-style-type: none"> 1. Replace box.
Machine will not accept coins.	<ol style="list-style-type: none"> 1. No power to the machine. 2. Defective changer. 3. The changer will accept only logical amount of money above the vend price. 4. Changer should be installed with power off. 5. Machine accepts only one coin. 	<ol style="list-style-type: none"> 1. Check wall outlet. 2. Replace changer. 3. Check pricing. 4. Turn power off then on. 5. Check mode box harness for loose connection. Check prices in th machine. Check for defective circuit breakers.
G&M selection shows "Make another selection"	<ol style="list-style-type: none"> 1. Defective G&M empty switch. 2. Defective motor. 3. Did not go through operate mode. 	<ol style="list-style-type: none"> 1. Replace switch or adjust actuator with product. 2. Replace motor. 3. Push operate mode switch
G&M keeps jamming.	<ol style="list-style-type: none"> 1. Ejector in the outer position. 2. Defective G&M chute. 	<ol style="list-style-type: none"> 1. Rephase ejector. 2. Replace chute.

This document is available free of charge to our customers at www.americanproducts.com

door - outside front

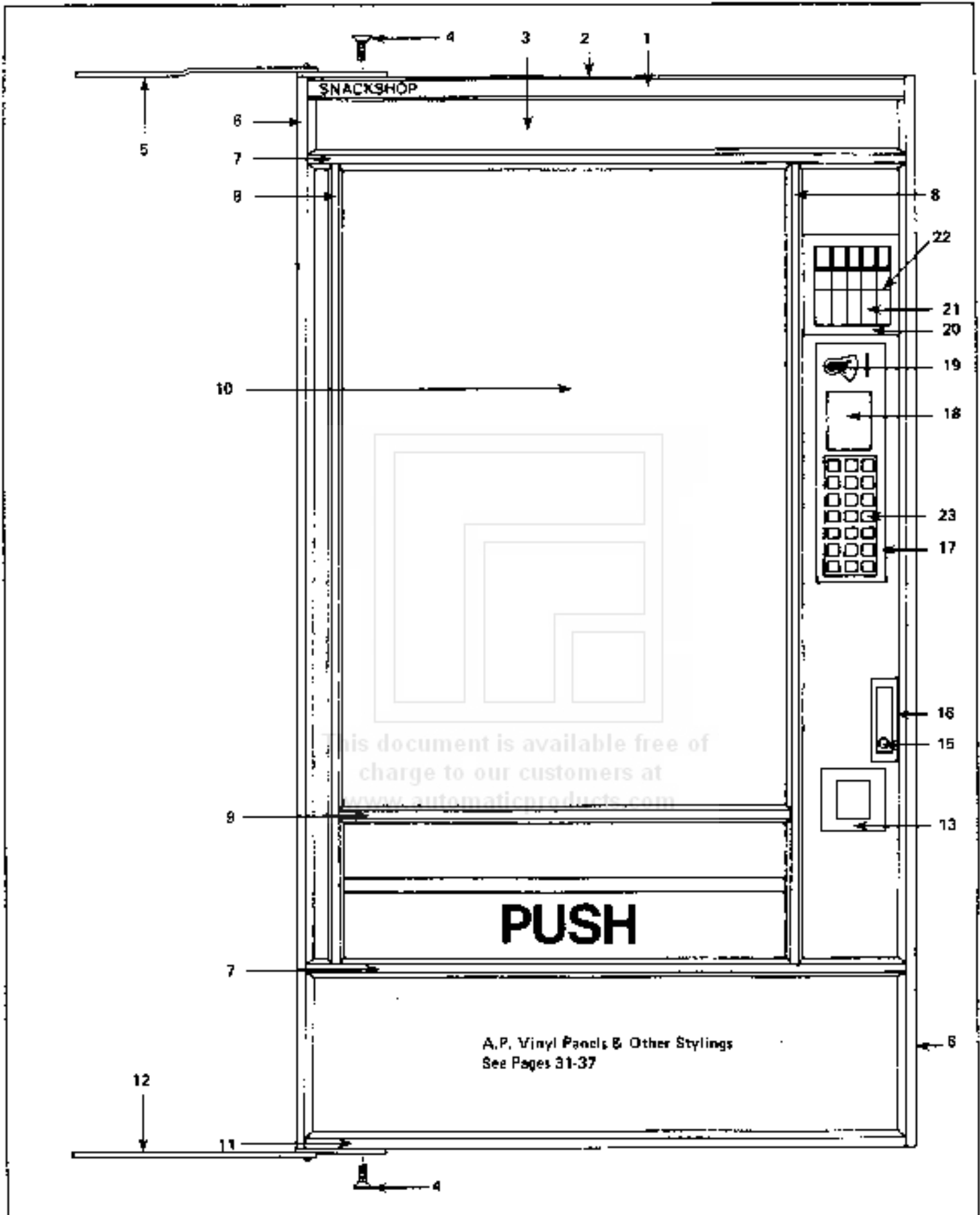

Item No.	Part No.	Description
1	20092-1	Insert, Top Trim, Snackslip.
	20092-2	Insert, Top Trim "Snackslip"
2	340044	Top, Trim For Use w/Panel Insert.
3	790070-1	Panel, Decorative Vinyl. (See Page 311)
4	420003-1	Screw, Flat Hd., (1/4-20 x 1/2.)
	420003	Screw, Flat Hd., Mech. (1/4-20 x 3/4)
5	640117	Top, Hinge Assembly.
6	340056-1	Trim, Outside Vertical, (Right and Left)
7	340054-2	Trim, Inside Horizontal.
8	340054-2B	Trim, Inside Vertical.
9	340054-1	Trim, Inside Horizontal.
10	440220	Window, Frame, (39-3/32 x 27 x 5/16)
	440186-2	Window, Frame, Lever.
11	340056-2	Trim, Outside Horizontal, (Top or Bottom)
12	640108	Lower Hinge.
13	600348	Coin Cup Trim.

Item No.	Part No.	Description
15	420071	Ace Lock w/2 Keys
	420071-1	Ace Lock w/1 Key
	420071-2	Ace Lock w/0 Key.
16	640088	Lock Handle Assembly.
17	600347	Coin and Main Button Trim.
18	440223	Glass Instruction 5-10-25g.
	440224	Glass Instruction 5-10-25-g1.
19	320046	Coin Return Lever.
20	600358	Trim G&M Display
21	440221	Glass G&M Display.
22	400100-1	Product Retainer Wire.
23	440225	Selector Button.

This document is available free of charge to our customers at www.automaticproducts.com

door - inside front

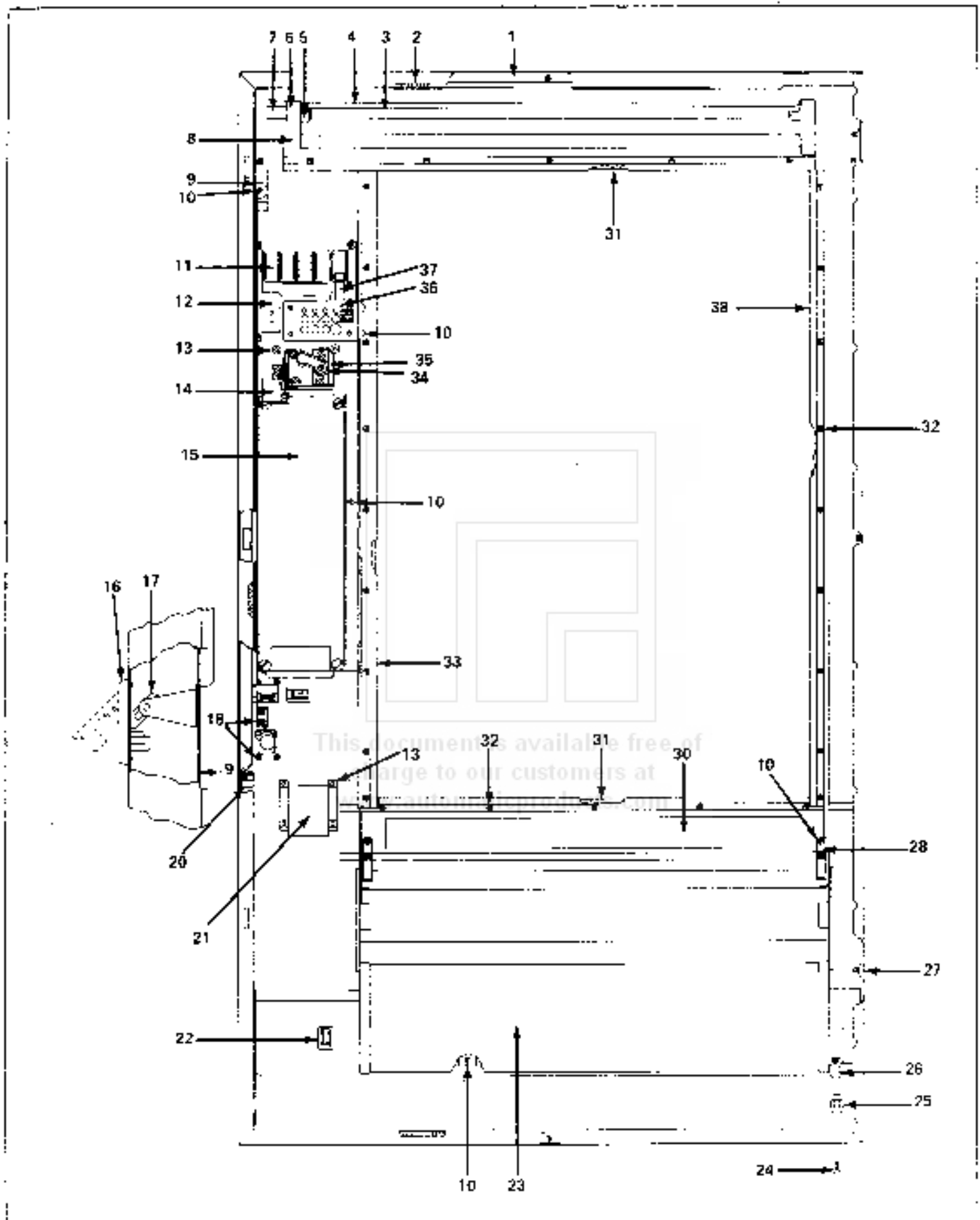

Item No.	Part No.	Description
1	203053-2 213895	Clamp, Illuminated Para., Upper. Window Clamps (Furniture Lock). Not Shown, used with above part.
2	461041-1	Insulation, Foam 1/4 x 1/4.
3	380022	Lamp, Fluorescent F18T8 CW-K30.
4	201178	Top Light Deflector.
5	380047	Socket, Fluorescent Lamp.
6	380080 421082-1	Socket, Starter. Screw, Rd. Hd. Mach. No. 4-36 x 3/4.
7	380023	Starter, FS 25.
8	660173-2 300241-2 200874	Assy. Complete, Window Bracket & Harness. Top Lamp and Window Bracket. Window Clamp (Furniture Lock). Not Shown, used with above part.
9	420029	Bumper, Rubber.
10	270-8R6	Screw, Pan Hd. Self Tap No. 8-32 x 3/8.
11	440222	Gum & Mint Display Box.
12	201145-1	Gum & Mint Hold Down Bracket-Lock.
13	404-8	Nut, Hex Hd. No. 8-32.
14	660289	Door Coin Chute, Plastic.
15	750115-1 660266 660293	Control Board, Button Panel, Control Board Cover. } See Page 29 for Itemized Parts
16	640089	Assy. Complete, Lock Handle.
17	200854 420010-7 420070 751-21	Cam, Lock Handle. Washer. Roller. Ring, Retaining No. 21
18	335-8R6	Screw, Pan Hd. Phillips, Taptite, No. 8-32 x 3/8.
19	600225-2	Assy. Door Locking Bar.

Item No.	Part No.	Description
20	200808	Bracket, Locking Bar Support.
21	201155 201156	Coin Return Cup. Coin Return Cup Door.
22	420096	Adhesive Backed Cable Guide.
23	660168-1	Assy. Delivery Bin, Complete. See Page 28 for Itemized Parts.
24	420003-1 420003	Screw - Flat Hd. 11/4-20-1/21. Screw - Flat Hd. Mach. 11/4 x 20 x 3/41.
25	300156 420003-1 420010-10	Nut, Special, Door Stop Anchor. Screw, Flat Hd. 11/4 20 1/21. Washer.
26	420088	Meta. Cable Clamp.
27	420097	Cord Clip.
28	200906	Delivery Bin Anchor Strap.
29	440084	Light Reflector.
30	460150	Insulation, Rubber. (Order Number of inches needed)
31	201-8R7	Screw Type B Rd. Hd. Phillips No. 6 x 7/16. Used around window & on Furniture Lock Machine-Top.
32	201136	Window Side Shield (clamp). Lock.
33	440175	Coin Return Extension Arm.
34	400067	Spring, Coin Return Lever.
35	200795	Coin Extension Arm & spring Mtg. Bracket.
36	750117	Assy. Complete, Mada Switch Box (See Page 29 for Itemized Parts)
37	640111	Gum & Mint Hold Down Bracket-Pivot.
38	201137	Window Side Shield (clamp)-Pivot.

This document is available free of charge to our customers at www.automaticproducts.com

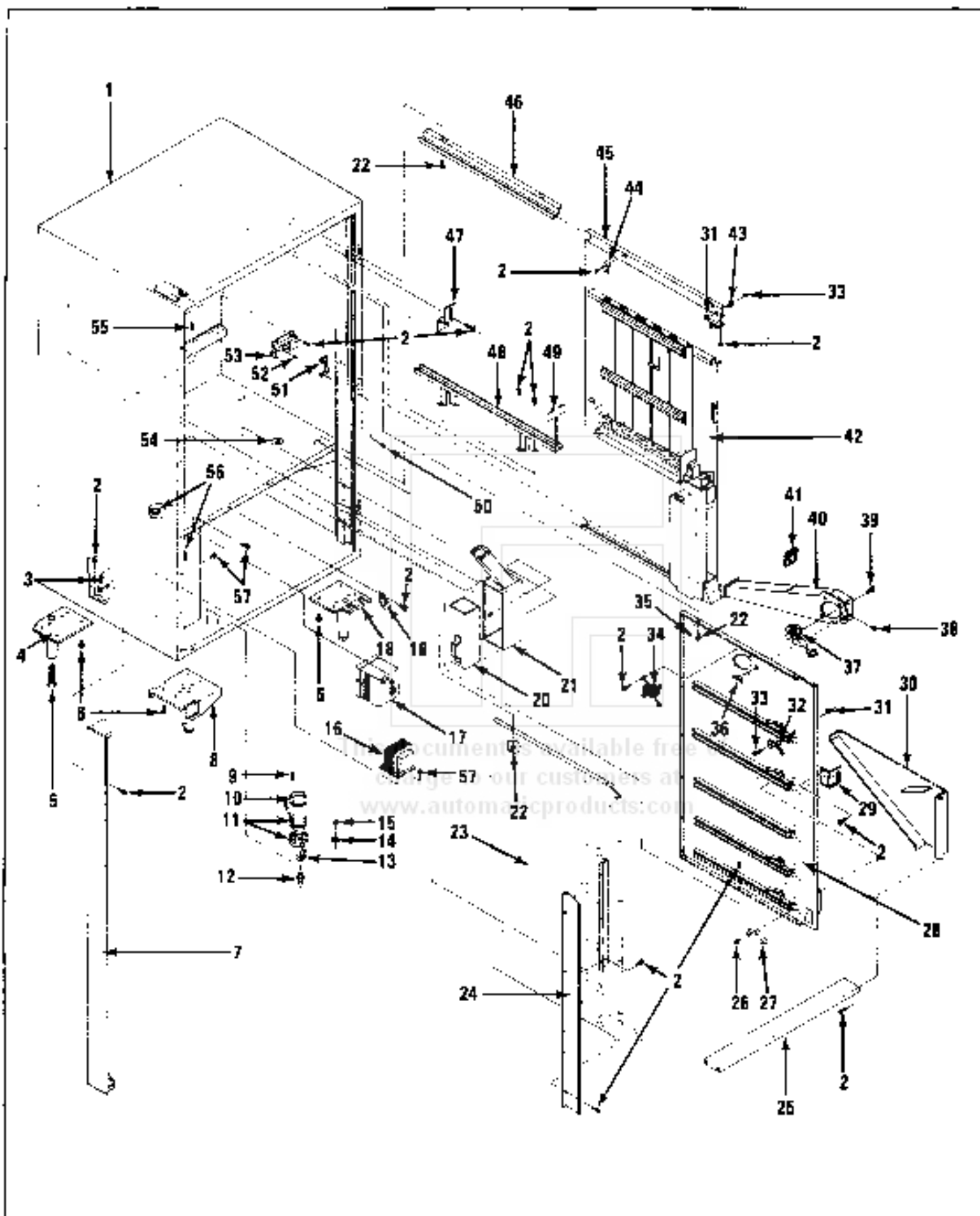

Item No.	Part No.	Description
1	750103	Cabinet Assy. Complete w/Lags, 6 shelf. 4000. Specify Color.
	750103-1	Cabinet Assy. Complete w/Lags, 6 shelf. 4000. Specify Color.
2	276-876	Screw, Pan Hd. Self-Tap (18-32 x 3/8)
3	660240-1	Assembly, Cam Set.
4	600195	Lag Assembly, Rear.
5	300100	Lag Leveler.
6	114-51-12	Screw, Hex Hd. Mach. (5/16-18 x 3/4).
7	600310	Assembly, Cabinet to Door Filler, Specify Color.
8	600302	Lag Assembly Front, Pivot Side.
9	277-10R16	Screw, Pan Hd. Self-Tap (10-32 x 1").
10	201042	Door Stop Plate.
11	440204	Door Stop Friction Pad.
12	300156	Nut, Special.
13	400095	Door Stop.
14	420010-10	Washer.
15	114-41-8	Screw, Hex Hd. Mach. (1/4-20 x 1/2).
16	360083	Transformer, 115V to 28V to 14V.
17	690270	Assembly, Main Interlock Box. (See Page 30 for Itemized Parts)
18	600197	Lag Assembly Front, Lock Side
19	420088	Clamp, Metal Cable.
20	600179-1	Cash Box w/Handle.
21	600386	Cash Box Mounting Bracket.
22	277-10R8	Screw, Pan Hd. Self-Tap (10-32 x 1/2).
23	660271	Assembly, Complete Left Side Panel, 5 shelf.
	600353	Panel, Left Side Only, 5 shelf.
	660270	Assembly, Complete Left Side Panel, 6 shelf.
	600352	Panel, Left Side Only, 6 shelf.
24	201142	Panel, Left Side Extension.
25	200830	Spacer, Right and Left Side Panel.
26	276-8R12	Screw, Pan Hd. Phillips (8-32 x 3/4).
27	440130	Front Roller Guide.
	440242	Front Roller Guide, Large.
28	660269	Assembly, Complete Right Side Panel, 5 shelf.
	600351	Panel, Right Side Only, 5 shelf.
	660268	Assembly, Complete Right Side Only, 6 shelf.
	600350	Panel, Right Side Only, 6 shelf.
29	640113-1	Assembly, Mole Switch Actuator.
30	600232-1	Chute, G/M Delivery.

Item No.	Part No.	Description
31	437-41	Nut, Keas (1/4-28)
32	440161	Shelf Lock.
33	300137	Screw, Shelf Roller
34	380215	Fan, Finger Guard.
35	404-8	Nut, Hex (8-32).
36	420023	Wing Nut (8-32)
37	750102	Kit, Complete Ventilating Fan.
	680278	Assembly, Fan-Complete Only.
38	420040-6	Snap Bushing.
39	277-10R6	Screw, Pan Hd. Self-Tap (10-32 x 1/2).
40	750102	Assembly, Complete, Fan and Chute Only.
	640118	Assembly, Fan Chute Only.
41	201176	Fan Screen.
42		Assembly, Complete, G/M Panel. (See Page 24 for Itemized Parts).
43	440123	Roller.
44	200816	Roller Channel Stop Bracket.
45	660180	Assembly, Complete Roller Channel.
	200827	Roller Channel Only.
46	600250	Roller Channel Mounting Bracket.
47	201177-1	Fan Hole Cover.
48	600376	Lower, G/M Guide Channel.
49	440023	Rivet, Nylon Guide.
50	262-8R8	Screw, Flat Hd. Self-Tap (18-32 x 1/2).
51	600300-1	Door Lock Catch, Heavy Duty.
52	420089	Screw, Flat Hd. 100 Deg. (16-32 x 1/2).
53	201138	Bracket, Receptacle Mounting.
54	420090	Grammet.
55	164-51-7.	Screw, Hex Hd. Sems (5/16-18 x 7/16).
56	420040-4	Snap Bushing 1-5/16 Dia.
57	276-8R6B	Screw, Pan Hd. #23 Phillips 18-32 x 3/8.

gum & mint sliding panel

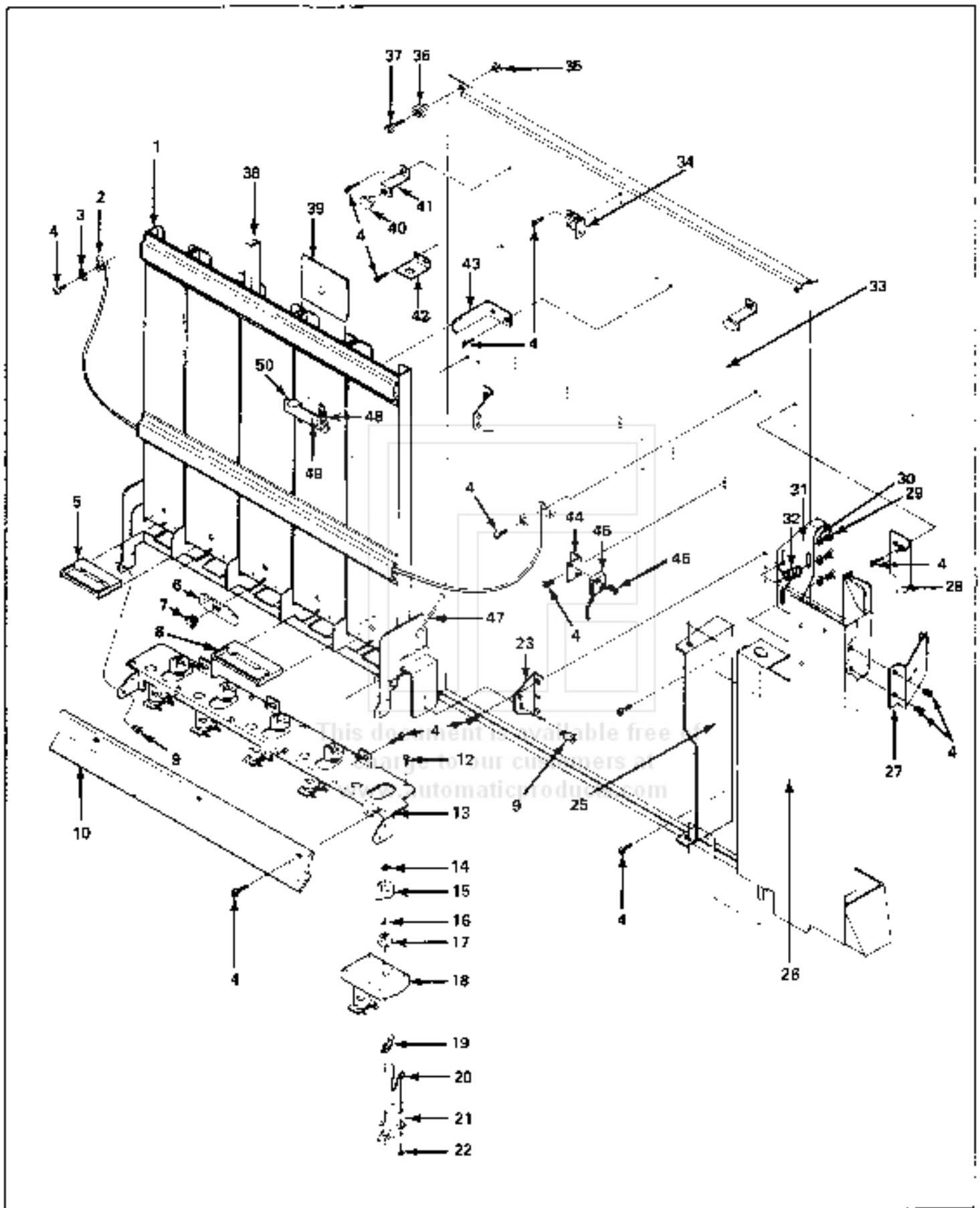

Item No.	Part No.	Description
1	680133-1	Assy. Complete G/M Stack w/Motors
	600262	G/M Stack Only.
2	400004	G/M Case Support.
3	420024	Washer, Star.
4	276 HHH	Screw, Pan Hd. Self-Tap. 18-32 x 3/8).
5	440143	Ejector, Narrow Column.
6	200990	Adapter, G/M.
7	420023	Nut, Wing (No. 8).
8	440247	Ejector, Wide Column.
9	300150	Screw, Shoulder. Motor Mount Pivot.
10	201124	G/M Deflector.
12	335-886	Screw, Pan Hd. Taptite Phillips (No. 8/32 x 3/8).
13	200917	Motor Mount, G/M.
14	751-21	Ring, Retaining (No. 21).
15	440151	Clutcher, Head Crank.
16	400079	Spring, G/M Motor Clutch.
17	440150	Clutch Pin.
18	750106-1	Assembly Complete. G/M Motor.
19	320050	Brake, Die Cast.
20	400072	Spring.
21	380070	Switch.
22	100-4-9	Screw, Rd. Hd. Mach. (4-40 x 3/16).
23	200918	G/M Pivot Bracket.
25	600377	Changer Hanging Brkt.
26	680287-1	Assy. Complete. Coin Changer Mounting Bracket
	600375-1	Changer Mounting Bracket Only.
	420080	Mars Changer. (MC-5000)
	420080-2	Coinco Changer. (300)
27	640115-1	Assy. Changer Latching Bracket

Item No.	Part No.	Description
28	200590-1	Handle.
29	116-886	Screw, Pan Hd. Mach. Phillips. (8-32 x 3/8).
30	420010-9	Wagner.
31	201131	Coin Return Slide Arm.
32	400099	Spring, Coin Return Arm Bracket.
33	600210-7	G/M Panel Only.
34	200816	Bracket, Roller Channel Stop.
35	47-41	Nut, Keys (1/4-28).
36	440123	Roller.
37	300137	Roller Screw.
38	200132	Spacer, G/M Column. 12 per Column.
39	440051	Adapter, Plastic. For Thin Mints.
40	420009	Rubber Bumper.
41	200815	Bracket, G/M Stack Spacer.
42	701126	Receptacle, Mounting Bracket
43	200814	G/M Stack Catch.
44	200918	Mounting Bracket, G/M Empty Switch.
45	650172	Assembly Switch and Bracket.
	380100	Switch, G/M Empty Only.
46	100-4-9	Screw, Pan Hd. Type 1 Phillips (4 x 9/16).
47	400046	Spring, Support Cable.
48	400020	Spring, Column Latch
49	300043	Rivet.
50	200131	Latch, G/M Stack.

product shelves

Item No.	Part No.	Description
	750064-4	Snack Shelf Ass'y. Complete W/O Delivery Spirals.
	750065-4	Candy Shelf Ass'y. Complete W/O Delivery Spirals.
1	600240	Snack Shelf.
2	750106	Vend Motor Assembly Complete.
3	305-8R8	Screw, Pan Hd. Phillips Plastite 17 x 1/2).
4	680256	Snack Shelf Harness Ass'y. Complete.
5	420089	Screw, 100° Flat Hd. No. 6-32 x 3/8.
6	600246	Plug Mounting Bracket.
7	276-8R6	Screw, Pan Hd. Phillips Self-Tap (8-32 x 3/8).
8	600206	15 Space Snack Spiral.
	600206-1	12 Space Snack Spiral.
	600206-2	10 Space Snack Spiral.
	600206-3	7 Space Snack Spiral.
9	640101	Spacer, Snack Shelf.
10	440128	Price & Selection Tab Holder.
11	460155	Price Tabs. 5¢ - 1.50
	460155-1	Price Tabs. Sheet of 100. 20¢ and 25¢.
	460155-2	Price Tabs. Sheet of 100. 30¢ and 35¢.
	460155-3	Price Tabs. Sheet of 100. 40¢ and 45¢.

Item No.	Part No.	Description
	460155-4	Price Tabs. Sheet of 100. 50¢ and 55¢.
	460155-5	Price Tabs. Sheet of 100. 60¢ and 65¢.
	460155-6	Price Tabs. Sheet of 100. 70¢ and 75¢.
	460155-7	Price Tabs. Sheet of 100. 80¢ and 85¢.
	460155-8	Price Tabs. Sheet of 100. 90¢ and 95¢.
	460155-9	Price Tabs. Sheet of 100. \$1.00 and \$1.05.
	460155-10	Price Tabs. Sheet of 100. \$1.10 and \$1.15.
	460155-11	Price Tabs. Sheet of 100. \$1.20 and \$1.25.
	460155-12	Price Tabs. Sheet of 100. \$1.30 and \$1.35.
	460155-13	Price Tabs. Sheet of 100. \$1.40 and \$1.45.
	460155-14	Price Tabs. Sheet of 100. \$1.50 and \$1.55.
	460155-15	Price Tabs. Sheet of 100. \$1.60 and \$1.65.
	460155-16	Price Tabs. Sheet of 100. \$1.70 and \$1.75.
12	460277	Item Tabs.
13	305-8R6	Screw, Pan Hd. Phillips, Plastite No. 8-16 x 3/8.
14	437-41	Nut, Keps. 1/4-28.
15	440123	Roller, Shelf.
16	300137	Screw, Shell Roller.
17	440126	Shelf Guide.
18	600239	Candy Shelf.
19	680257	Candy Shelf Harness Ass'y. Comp. etc.

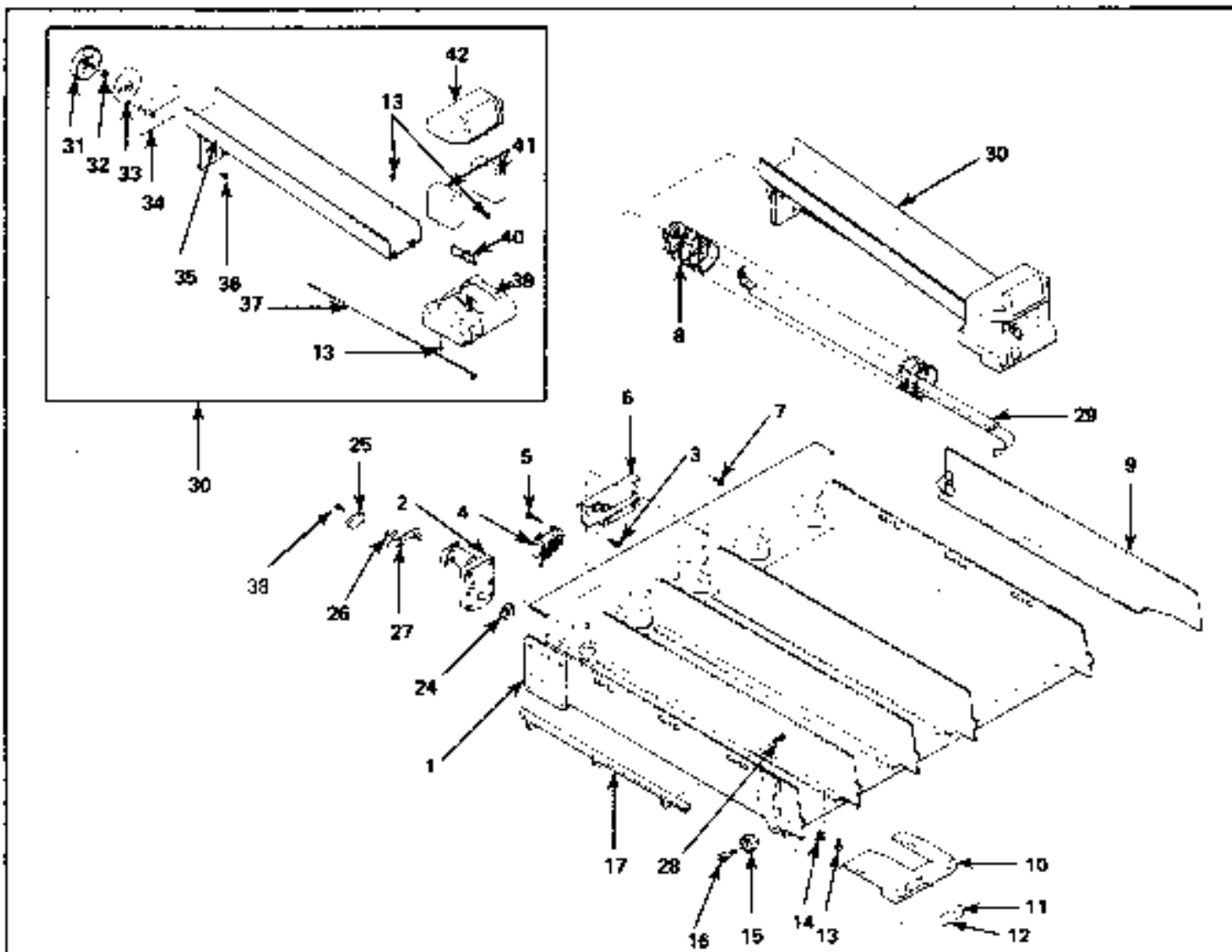

Item No.	Part No.	Description
20	600205	24 Space Candy Spira.
	600205-1	13 Space Candy Spira.
	600205-2	15 Space Candy Spira.
	600205-3	12 Space Candy Spira.
	600205-4	30 Space Candy Spira.
21	440141	Candy Product Pusher.
22	560178	Candy Spacer Ass'y.
23	440127	Price & Selection Tab Holder.
24	440125	Spiral Retainer Only.
25	320070	Switch Only.
26	400072	Spring.
27	320050	Brake Die Cast.
28	420092	Screw, Cr. #8-Type 4L.
29	960191	Product Rail Assy. For use w/Candy Spiral
	660191-2	Product Rail Assy. For use w/Snack Spiral.

Item No.	Part No.	Description
	660191-4	Product Rail Assy. For use w/Snack Spira. Pantry.
30	750083	K.A. Can Dispenser Ass'y.
31	440201	Drive Cam, Rear.
32	Retaining Ring, #31.	
33	440200	Drive Cam, Front.
34	540109	Cam, Mounting Brkt & Spring Ass'y.
35	600309	Can Dispenser, Trough Only.
36	360004	Shoulder Screw.
37	400094	Actuator Wire.
38	100-4-9	Screw, Ro. Hd. Mech. #4-40 x 3/4.
39	440196	Price and Selection Tab.
40	440199	Stop Lever
41	440198	Leg, Top Can Guide & Sign Trim.
42	440197	Top Can Guide & Sign Trim
43	360296	Product Guide Assy. For use w/Thin products.

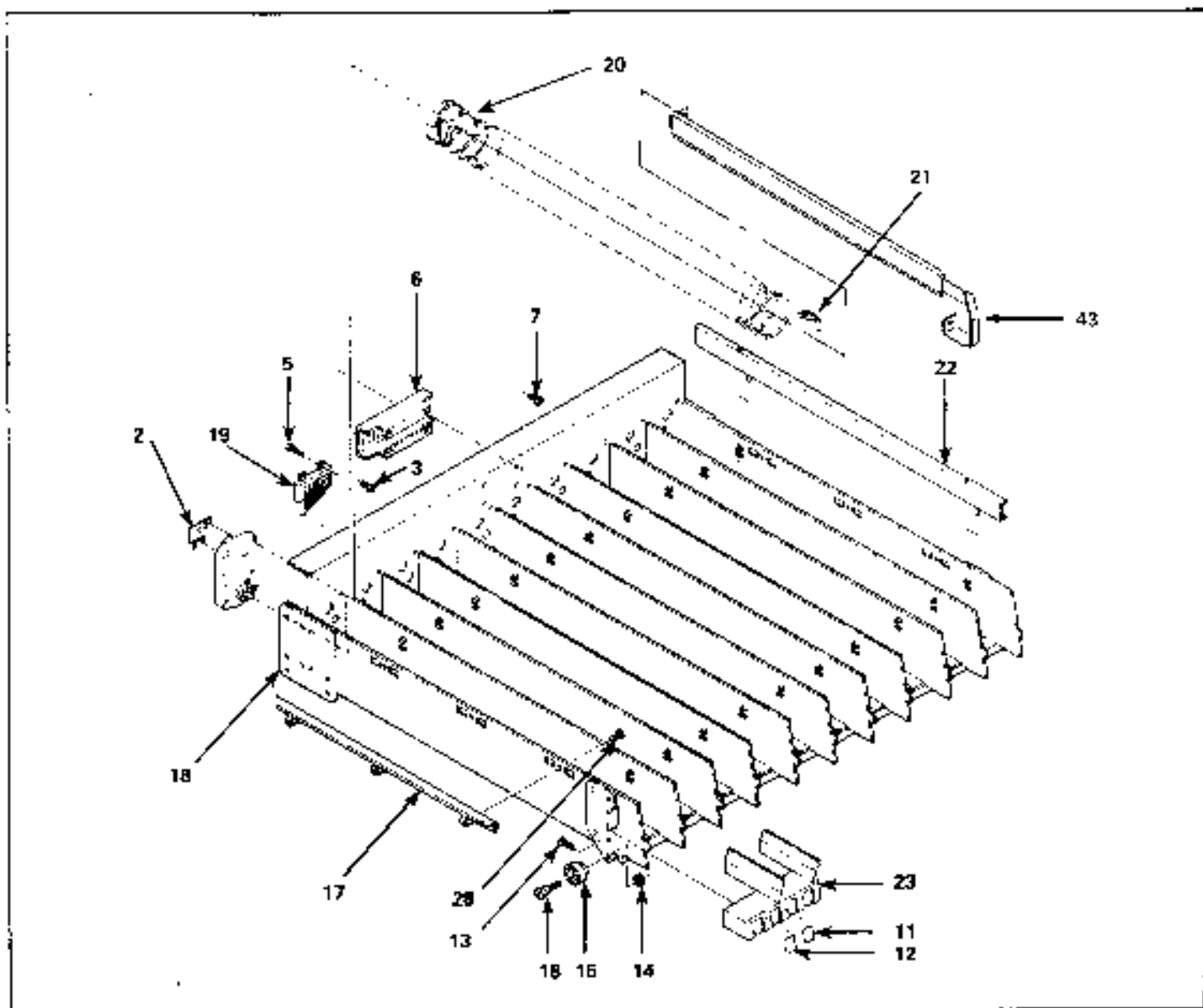

delivery bin

Item No.	Part No.	Description
1	660169-7 600259-1	Delivery Bin Ass'y, Comp-ete, Delivery Bin.
2	640099	Arm Mounting Bracket (Lock Side).
3	438-8	Nut, Keas. No. 8-32.
4	640098	Inner Door Bin Arm.
5	640100	Bin Door Drive Ass'y. (Lock Side)
6	751-37	Retaining Ring No. 37
7	276-8R6	Screw, Pan Hd. Philips, Self Tap, No. 8-32 x 3/8"
8	640097	Door Drive Arm.

Item No.	Part No.	Description
9	440129	Door Bearing.
10	200763	Inner Door.
12	600258	Door, Delivery Bin.
13	420029	Rubber Bumper.
14	640100-1	Bin Door Drive Ass'y. (P-wt Side)
15	640099-1	Arm Mounting Bracket. (P-wt Side)
16	200902	Baffle, Rear Delivery Bin.
17	200906	Delivery Bin Anchor Strap.
18	660238	Delivery Bin Pad Ass'y. For Can Dispenser.

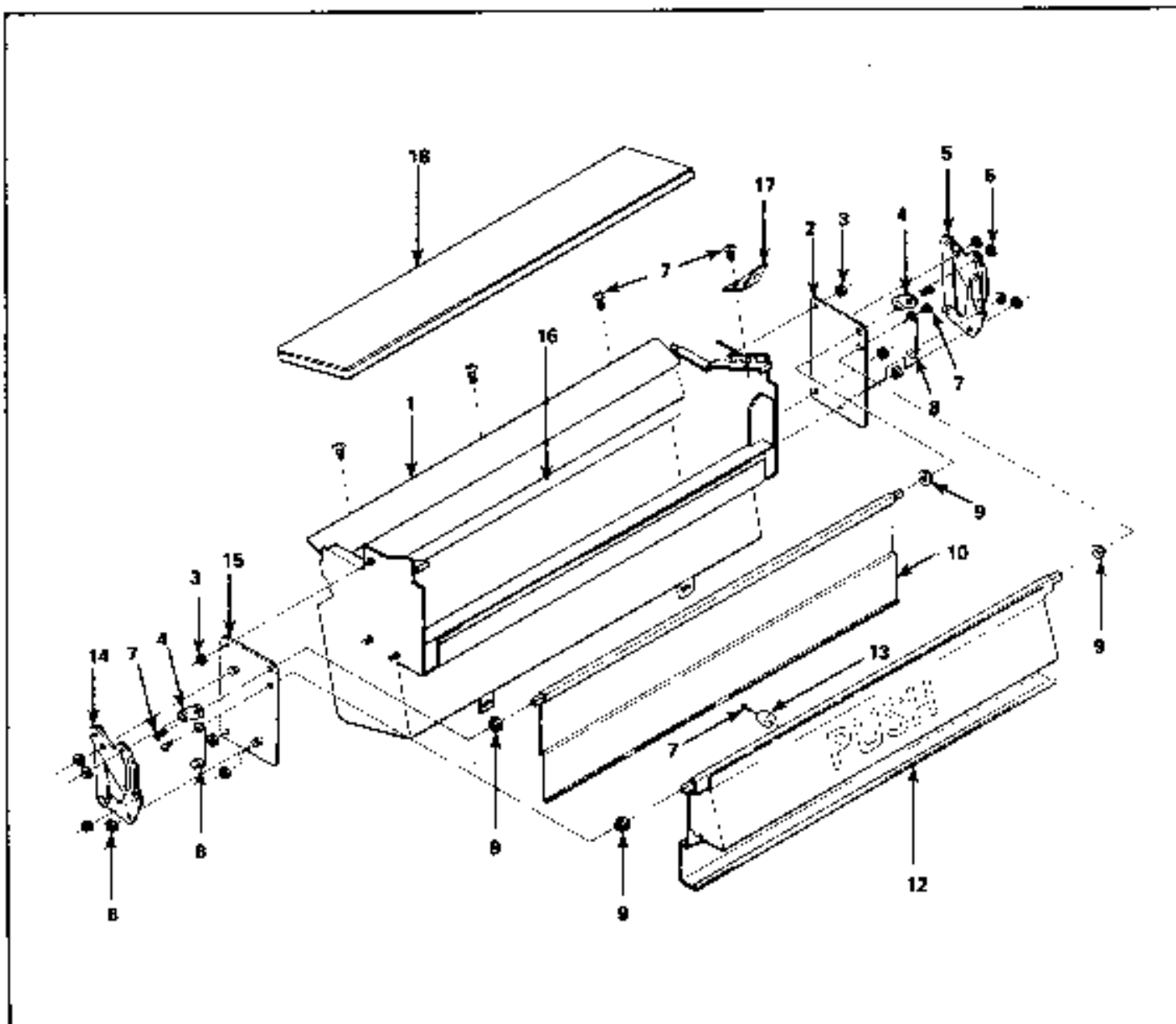

main button and panel assembly

Item No.	Part No.	Description
1	320046	Coin Return Lever
2	660281	Assembly Complete, Button Trim & Panel.
	690347	Trim Coin Button Only.
3	201147	Coin Return Lever Back Plate.
4	440227	Spacer, Coin Extension Arm Bracket.
5	200795	Coin Extension Arm/Spring Bracket.
6	404-8	Hex Nut (3-32).
7	400067	Spring, Coin Return Lever.
8	440175	Coin Return Extension Arm.
9	335-8R6	Screw, Pan Hd. Tap-Lite (8-32 x 3/8).
10	660266	Harness, Mode Switch Box.
11	404-6	Hex Nut (6-32).
12	750117	Assembly Mode Switch Box Complete
13	420127	Spacer, Mode Switch Board.
14	201127	Mode Switch Bracket Only.
15	276-8R6	Screw, Pan Hd. Self-Tap (8-32 x 3/8)
16	100-6A12	Screw, Round Hd. 16-32 x 3/4.
17	420124	Hole Plug.
18	201-6R6	Screw, Rd. Hd, Phillips 16-38 x 3/8.
19	440230	Plastic Support.

Item No.	Part No.	Description
20	300161	Board Spacer, Long.
21	201704	Board Spacer Lock.
22	360293	Assembly Control Board Cover.
	201250	Control Board Cover Only.
23	660289	Door Coin Chute, Plastic.
24	420125	Retainer.
25	360162	Shoulder Screw.
26	420130	Nut, Serrated Flange 16-32.
27	460283	Rubber Grommet
28	750115-1	Assembly, Complete Control Board w/Plastic Support
	660295	Control Board, Lower Part Only.
29	300158	Board Spacer.
30	360097	Connector Ribbon.
31	660294	Board, Digital Display only w/Plastic Support
32	75118	Retaining Ring
33	660266	Selector Switch Panel.
34	440225	Selector Button.
35	440223	Coin Instruction Glass 5-10-25¢
	440224	Coin Instruction Glass 5-10-25-\$1 00.

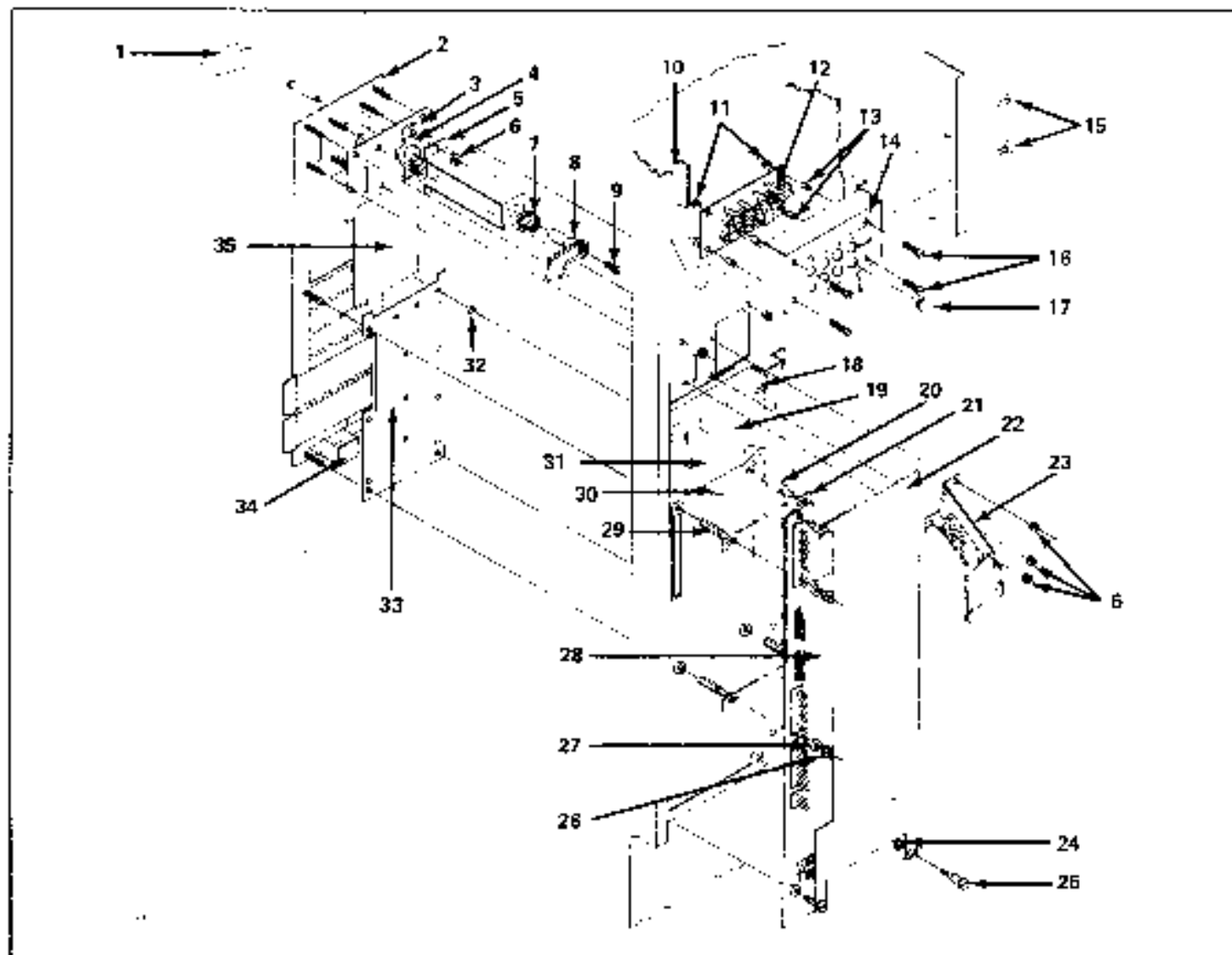

main interlock box

Item No.	Part No.	Description
1	201153 680270	Breaker, Ballast and Switch Bracket Only. Assembly Complete.
2	380101-1	Circuit Breaker, w/ Nut 3 Amp.
3	380126	Toggle Switch w/ Nut.
4	380189	2 Pin Molex Receptacle.
5	201189	Cover, Ballast and Switch Bracket
6	276-844	Screw, Pan Hd. No. 6-32 x 1/4".
7	380107	6 Pin Molex Receptacle.

Item No.	Part No.	Description
9	380035	3 Pin Molex Receptacle.
9	390034	3 Pin Molex Plug.
10	380106	6 Pin Molex Plug.
11	276-846B	Screw, Pan Hd. #23 Phillips 18-32 x 3/8".
12	680278	Assy. Complete, Ballast
13	680269	Under Shelf Harness. Not shown!
14	200-GRG	Screw, Type A Pan Hd. No. 6 x 3/8"

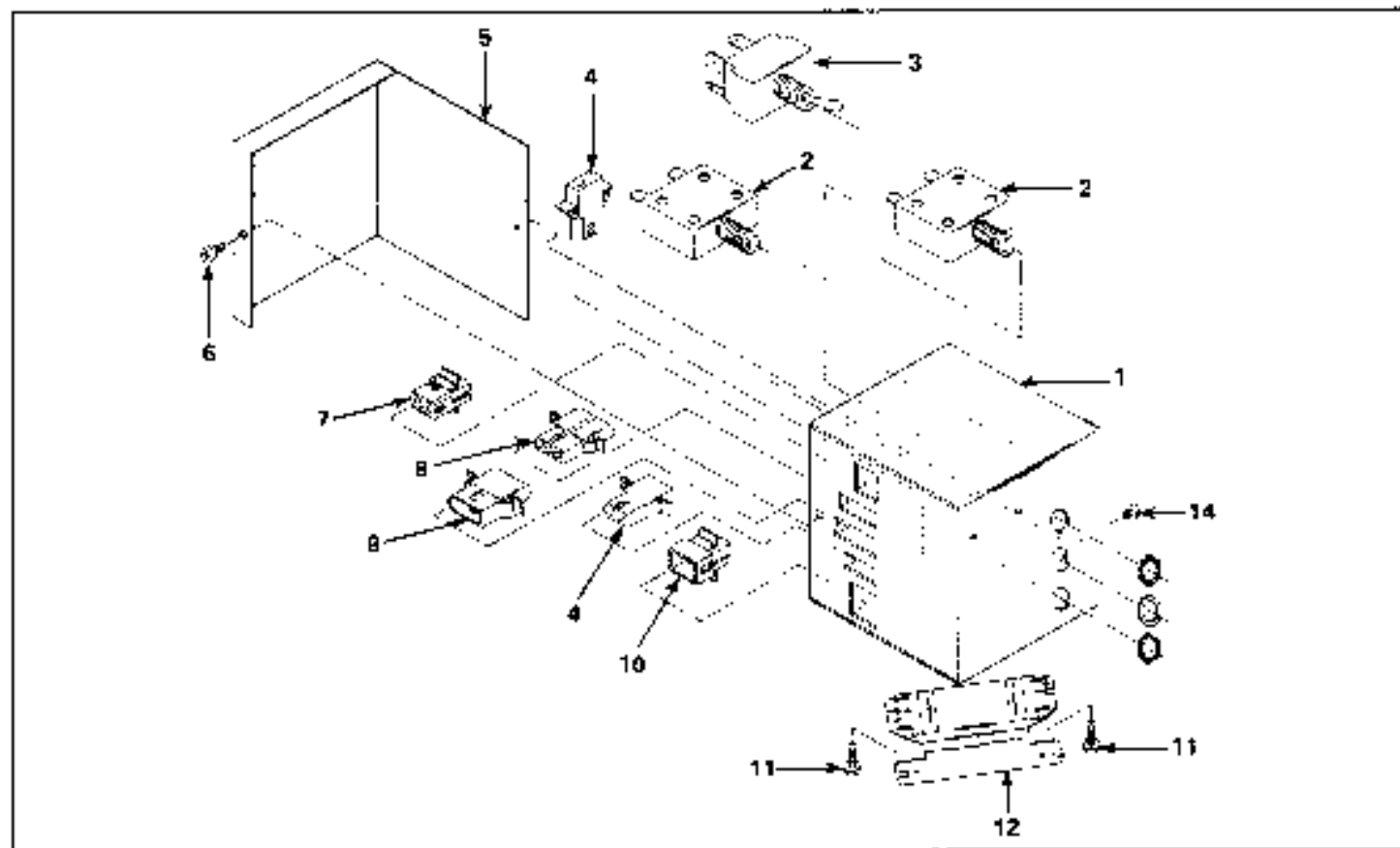

electrical harnesses

Part No.	Description
660740-1	Cord Set Complete
360096	Cord Set
680138	Lamp Harness Assembly
680139-2	Light Cord Harness—Door to Cabinet (Long)
680139-3	Light Cord Harness (Short)
680266	Pantry Shelf Harness
680267	Candy Shelf Harness
680269	Sum & Mint Harness

Part No.	Description
680264	Cabinet Back Harness (4600)
680265	Cabinet Back Harness (4500)
680268	Mode Switch Board Harness
680269	Under Shelf Harness
680270	Under Shelf Harness Assembly
680275	Fan Cord Harness
680280	Mars B. Coinco Changer Harness.

Item No.	Part No.	Description	
1		PLATE, COVER UP.	
	200070-3	Painted, Specify Color.	
	200070-4	Presidential Walnut Vinyl.	
	200070-5	Honeytone Teak Vinyl.	
	200070-6	Spanish Oak Vinyl.	
	200070-7	Regency Walnut Vinyl.	
	200070-8	Imperial Rosewood Vinyl.	
	200070-14	Kashmir Walnut Vinyl.	
	2		PANEL, LEFT SIDE VERTICAL.
		200792-17	Presidential Walnut Vinyl.
200792-18		Regency Walnut Vinyl.	
200792-19		Kashmir Walnut Vinyl.	
200792-20		Honeytone Teak Vinyl.	
200792-21		Spanish Oak Vinyl.	
200792-22		Imperial Rosewood Vinyl.	
200792-23		Painted, Specify Color.	
3			PANEL, DELIVERY TRAY.
		200793-1	Painted, Specify Color.
	200793-2	Presidential Walnut Vinyl.	
	200793-3	Imperial Rosewood Vinyl.	
	200793-4	Spanish Oak Vinyl.	
	200793-5	Honeytone Teak Vinyl.	
	200793-6	Regency Walnut Vinyl.	
	200793-7	Kashmir Walnut Vinyl.	
4		PANEL, LOWER HORIZONTAL.	
	200296-36	Presidential Walnut Vinyl.	
	200296-37	Regency Walnut Vinyl.	
	200296-38	Kashmir Walnut Vinyl.	
	200296-39	Honeytone Teak Vinyl.	
	200296-40	Spanish Oak Vinyl.	
	200296-41	Imperial Rosewood Vinyl.	
	200296-42	Painted, Specify Color.	
	5		PANEL, RIGHT SIDE VERTICAL.
		201209	WO/G&M, Presidential Walnut Vinyl.
201209-1		WO/G&M, Regency Walnut Vinyl.	
201209-2		WO/G&M, Kashmir Walnut Vinyl.	
201209-3		WO/G&M, Honeytone Teak Vinyl.	
201209-4		WO/G&M, Spanish Oak Vinyl.	
201209-5		WO/G&M, Imperial Rosewood Vinyl.	
201209-6		WO/G&M, Painted, Specify Color.	
201209-7		W/G&M, Presidential Walnut Vinyl.	
201209-8		W/G&M, Regency Walnut Vinyl.	
201209-9		W/G&M, Kashmir Walnut Vinyl.	
201209-10		W/G&M, Honeytone Teak Vinyl.	
201209-11		W/G&M, Spanish Oak Vinyl.	
201209-12		W/G&M, Imperial Rosewood Vinyl.	
201209-13	W/G&M, Painted, Specify Color.		
6	600334-1	Door Only, Specify Color.	

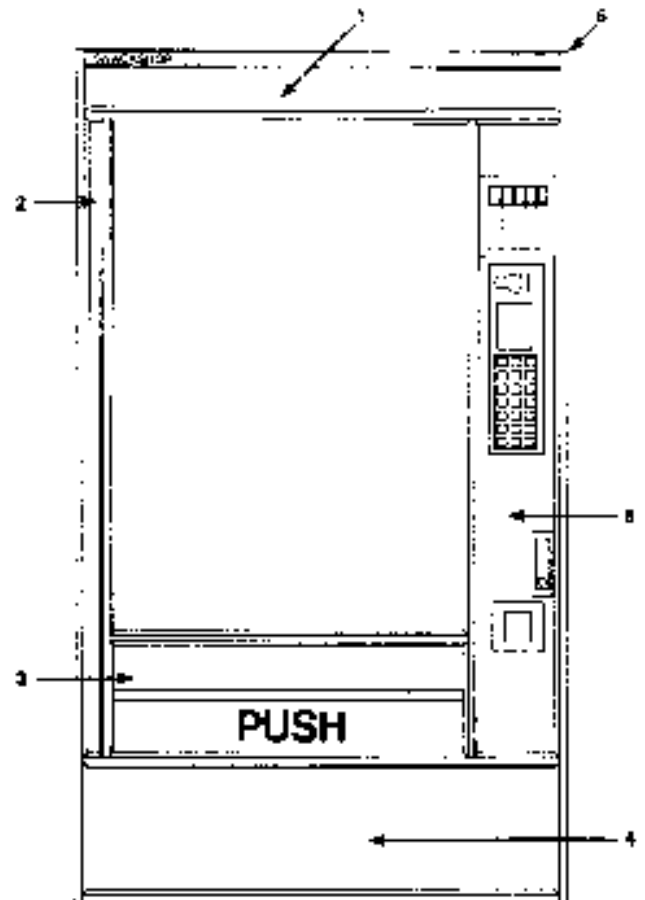

crown style

Item No.	Part No.	Description
1	340056-2	Trim, Outside Horizontal Top and Bottom.
2	440028-3	Panel, Illuminated, National Style Snacks.
	440006-4	Panel, Illuminated, Snackshop
3	200161	Panel, Decorative, Horizontal Gold.
	200371-1	Cover Jo Plate, Black.
4	340054-8	Trim, Inside Horizontal.
5	340054-2B	Trim, Inside Vertical, (Right or Left)
6	200797-17	Panel, Left Side Vertical, Presidential Walnut.
7	340056-1	Trim, Outside Vertical, (Right or Left)
8	340054-1	Trim, Inside Horizontal.
9	200290-36	Panel, Lower Horizontal, Presidential Walnut
10	200733-2	Panel, Delivery Tray, Presidential Walnut.
11	201209	Panel, Right Side Vertical, WO/G&M, Presidential Walnut.
	201209-7	Panel, Right Side Vertical, W/G&M, Presidential Walnut
12	600334-1	Door Only. Specify Color.

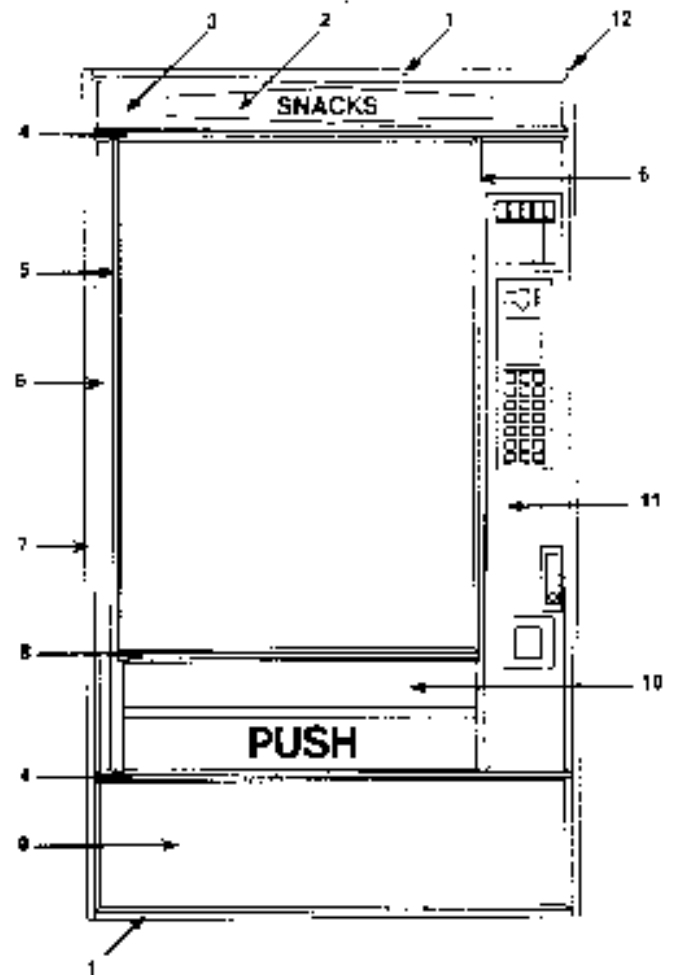

Item No.	Part No.	Description
1	340368-1	Trim, Outside Horizontal, Top and Bottom, Bronze
2	140059 429101	Flash, Frame Furniture Style. Nut, Pal Plastic Boss
3	460375-3	Panel, Illuminated, Furniture Style, Snacks
4	140054-12	Trim, Inside Vertical, Bronze
5	200792-17	Panel, Left Side Vertical, Presidential Walnut
6	340056-11	Trim, Outside Vertical, (Right and Left) Bronze
7	340054-4	Trim, Inside Horizontal, Bronze
8	660105 217-5-3	Handle, Decorative. Screw, Decorative Handle Mounting
9	201095	Panel, Lower Horizontal, Furniture Style
10	200793-2	Panel, Delivery Tray, Presidential Walnut
11	201209 201209-7	Panel, Right Side Vertical, W/G&M, Presidential Walnut. Panel, Right Side Vertical, W/G&M, Presidential Walnut
12	600334-1	Door Only, Specify Color

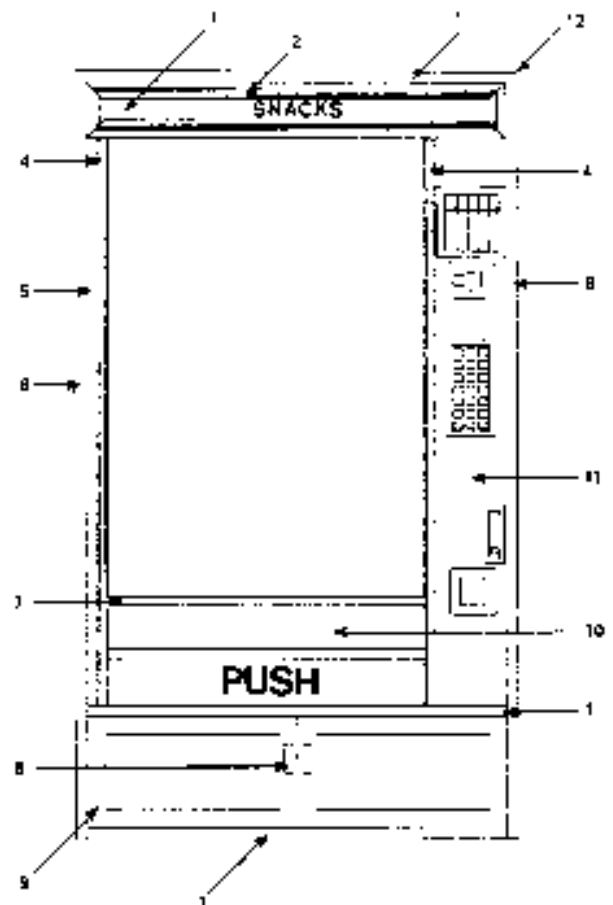

Item No.	Part No.	Description
1	860231-1	Trim, Top or Bottom, Bronze
2	440368	Frame, Top Trim
3	440169	Frame, Top Inner
4	440174	Frame, Top Inner Insert
5	660226	Panel, Decorative Ass'y. (Canet)
6	340054-29	Trim, Inside Vertical, Bronze, (Right or Left)
7	200792-17	Panel, Left Side Vertical, Presidential Walnut
8	340056-11	Trim, Outside Vertical, Bronze, (Right or Left)
9	340054-4	Trim, Inside Horizontal, Bronze
10	660227-4	Panel, Lower Horizontal, (Canet)
11	440228	Frame, Bottom
	261-6A5	Screw, Rd. Hd, Phillips 16-18 x 5/16
	211-6A6	Screw, Truss Hd, Type B (#8 18)
	201-6A7	Screw, Rd. Hd, Phillips 15-18 x 7/16
	420101	Nut, Pal Plastic Boss
12	460237	Handle, Decal
13	201209 201209-7	Panel, Right Side Vertical, W/G&M, Presidential Walnut. Panel, Right Side Vertical, W/G&M, Presidential Walnut
14	200793-2	Panel, Delivery Tray, Presidential Walnut
15	600303-9	Door Only, Specify Color

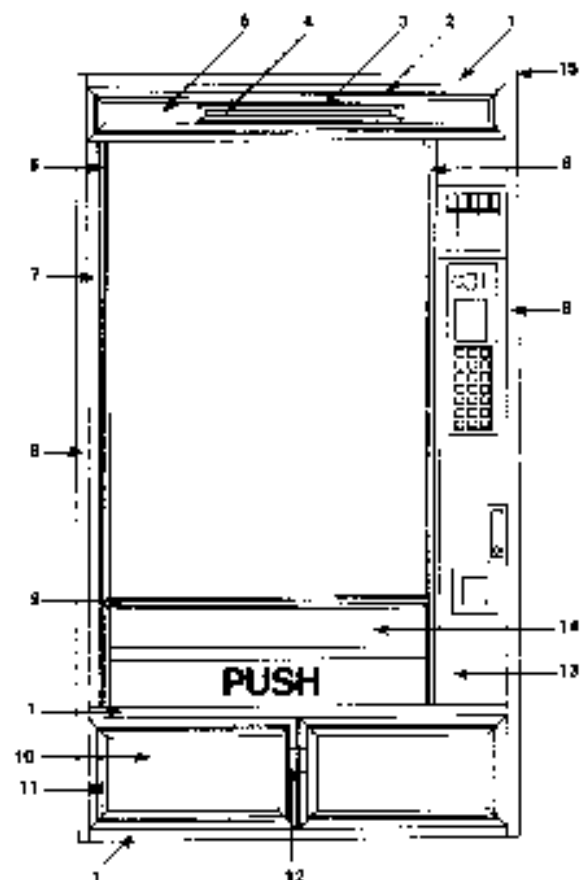

imperial style

Item No.	Part No.	Description
1	660231-3	Trim, Outside Horizontal. (Top or Bottom) w/Black Stripe.
2	440159	Frame, Plastic.
	271-8R4	Screw, Truss Hd, Phillips, Type B (8 x 1/4).
3	440154	Panel, Insert.
	750104	Kit, Complete, Cover-up Plate.
4	200922	Panel, Decorative, Presidential Walnut.
5	660231-8	Trim, Inside Horizontal, W/Black Stripe
6	340054-28	Trim, Inside Vertical. (Right or Left)
7	200792-17	Panel, Left Side Vertical, Presidential Walnut.
	660216-6	Panel, Left Side Vertical, Burlap.
8	340055-10	Trim, Outside Vertical. (Right or Left)
9	340054-1	Trim, Inside Horizontal.
10	200793-2	Panel, Delivery Tray, Presidential Walnut.
11	200296-36	Panel, Lower Horizontal, Presidential Walnut.
12	201209	Panel, Right Side Vertical, W/G&M, Presidential Walnut.
	660217-15	Panel, Right Side Vertical, W/G&M, Burlap.
	201209-7	Panel, Right Side Vertical, W/G&M, Presidential Walnut.
	660217-16	Panel, Right Side Vertical, W/G&M, Burlap.
13	600334-1	Door Only, Specify Color.

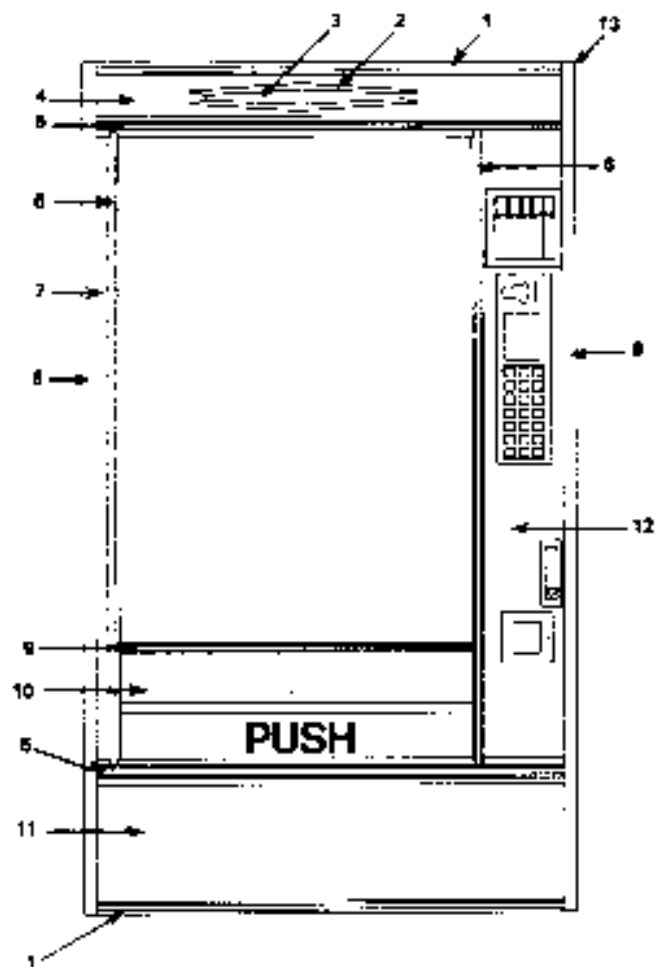

Item No.	Part No.	Description
1	340042	Trim, Top only.
2	201260	Vinyl Insert, Top Trim, Stainless.
3	200073-16	Plate Cover Jo. Stainless.
4	340054-8	Trim, Inside Horizontal.
5	340054-28	Trim, Insert Vertical, Left or Right.
6	200792-24	Panel Vinyl, Left Side Vertical
7	340056-6	Trim, Outside Vertical, Black.
8	340054-1	Trim, Inside Horizontal.
9	200793-15	Panel Vinyl, Delivery Tray, Stainless.
10	200720-37	Panel Vinyl, Lower Horizontal, Stainless. Use W/D Lower Trim.
11	201209-16	Panel Right Side Vertical, W/D Gum & Mint.
	201209-17	Panel Right Side Vertical, W/Gum & Mint.

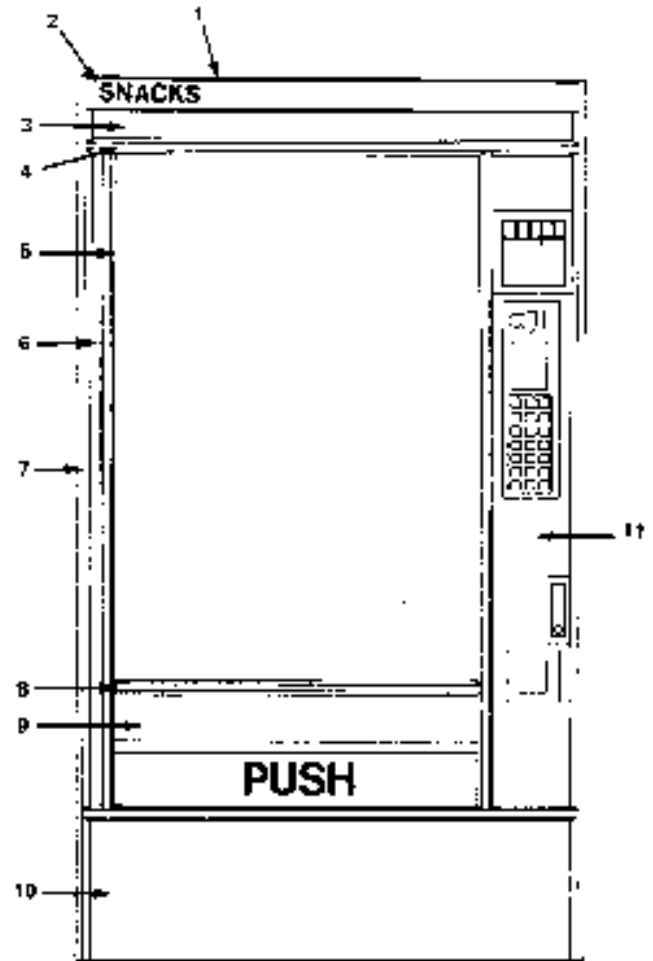

award style

Item No.	Part No.	Description
1	340042	Trim, Top Only.
2	200526	Vinyl, Insert, Top Trim, Imperial Rosewood.
	200526-2	Vinyl, Insert, Top Trim, Presidential Walnut.
3	200070-4	Plate, Cover Up, Presidential Walnut.
	200070-8	Plate, Cover Up, Imperial Rosewood.
4	340054-9	Trim, Inside Horizontal, Black.
5	340054-27	Trim, Inside Vertical, Black. (Right or Left)
6	200792-17	Panel, Vinyl, Left Side Vertical, Presidential Walnut.
	200792-22	Panel, Vinyl, Left Side Vertical, Imperial Rosewood.
7	660231-13	Trim, Outside Vertical, w/Black Strips. (Right or Left)
8	340054-10	Trim, Inside Horizontal, Black.
9	200720-21	Panel, Lower Horizontal, Presidential Walnut.
	200720-25	Panel, Lower Horizontal, Imperial Rosewood.
10	200793-2	Panel, Delivery Tray, Presidential Walnut.
	200793-3	Panel, Delivery Tray, Imperial Rosewood.
11	201209	Panel, Right Side Vertical, WO/G&M, Presidential Walnut.
	201209-5	Panel, Right Side Vertical, WO/G&M, Imperial Rosewood.
	201209-7	Panel, Right Side Vertical, W/G&M, Presidential Walnut.
	201209-12	Panel, Right Side Vertical, W/G&M, Imperial Rosewood.
12	600334-1	Door Only. Specify Color.
WHEATSTONE STYLE		
1	340042-3	Trim, Top Only.
2	660220	Vinyl, Insert, Top Trim, Wheatstone.
3	660221	Plate, Cover Up, Top Trim, Bronze.
4	340054-25	Trim, Horizontal.
5	340054-30	Trim, Inside Vertical, (Left and Right)
6	660216-7	Panel, Left Side Vertical, Bronze.
7	340055-11	Trim, Outside Vertical, (Left and Right)
8	340054-4	Trim, Inside Horizontal.
9	660218-3	Panel, Lower Horizontal, Wheatstone.
10	660219	Panel, Delivery Tray, Bronze.
11	660217-17	Panel, Right Side Vertical, WO/G&M, Bronze.
	660217-18	Panel, Right Side Vertical, W/G&M, Bronze.
12	600334-1	Door Only. Specify Color.

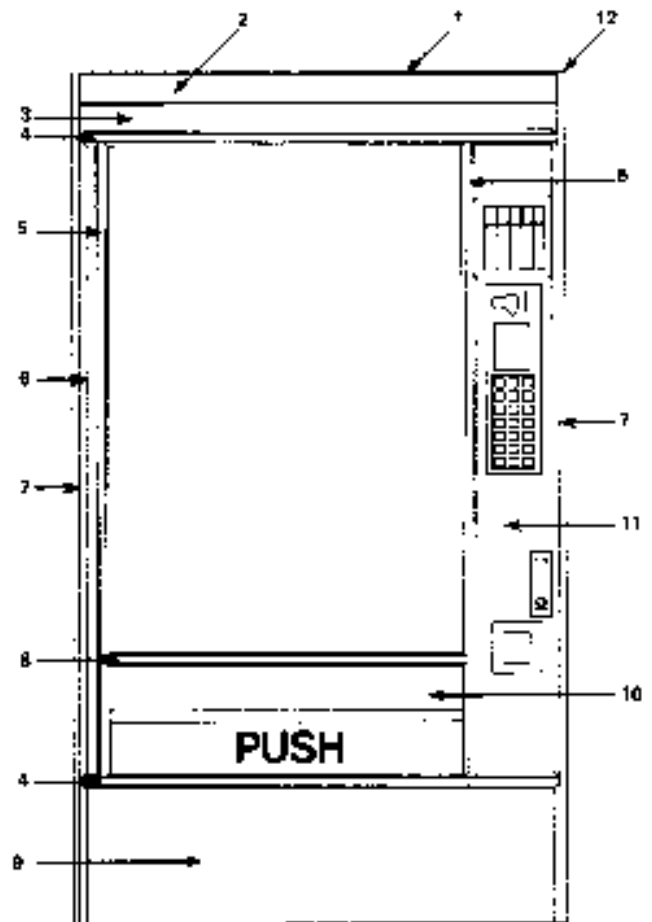

Item No.	Part No.	Description
1	340040	Trim, Top Only.
2	200070-3	Plate, Cover Up, Painted. Specify Color.
	200070-4	Plate, Cover Up, Presidential Walnut.
	200070-5	Plate, Cover Up, Honeytone Teak.
	200070-6	Plate, Cover Up, Spanish Oak.
	200070-7	Plate, Cover Up, Regency Walnut.
3	340054-8	Trim, Inside Horizontal.
4	340054-28	Trim, Inside Vertical. (Right and Left)
5	200792-17	Panel, Left Side Vertical. Presidential Walnut.
	200792-18	Panel, Left Side Vertical. Regency Walnut.
	200792-20	Panel, Left Side Vertical. Honeytone Teak.
	200792-21	Panel, Left Side, Vertical. Spanish Oak.
	200792-23	Panel, Left Side Vertical. Painted. Specify Color.
6	340056-1	Trim, Outside Vertical. (Right and Left)
7	340054-1	Trim, Inside Horizontal.
8	200793-1	Panel, Delivery Tray. Painted. Specify Color.
	200793-2	Panel, Delivery Tray. Presidential Walnut.
	200793-4	Panel, Delivery Tray. Spanish Oak.
	200793-5	Panel, Delivery Tray. Honeytone Teak.
	200793-6	Panel, Delivery Tray. Regency Walnut.
9	200720-21	Panel, Lower Horizontal. Presidential Walnut.
	200720-22	Panel, Lower Horizontal, Regency Walnut.
	200720-24	Panel, Lower Horizontal, Honeytone Teak.
	200720-25	Panel, Lower Horizontal, Spanish Oak.
	200720-27	Panel, Lower Horizontal, Painted. Specify Color.
10	201209	Panel, Right Side Vertical. W/G&M. Presidential Walnut.
	201209-1	Panel, Right Side Vertical. W/G&M. Regency Walnut.
	201209-3	Panel, Right Side Vertical. W/G&M. Honeytone Teak.
	201209-4	Panel, Right Side Vertical. W/G&M. Spanish Oak.
	201209-6	Panel, Right Side Vertical. W/G&M. Painted. Specify Color.
	201209-7	Panel, Right Side Vertical. W/G&M. Presidential Walnut.
	201209-8	Panel, Right Side Vertical. W/G&M. Regency Walnut.
	201209-10	Panel, Right Side Vertical. W/G&M. Honeytone Teak.
	201209-11	Panel, Right Side Vertical. W/G&M. Spanish Oak.
	201209-13	Panel, Right Side Vertical. W/G&M. Painted. Specify Color.
11	600334-1	Door Only. Specify Color.

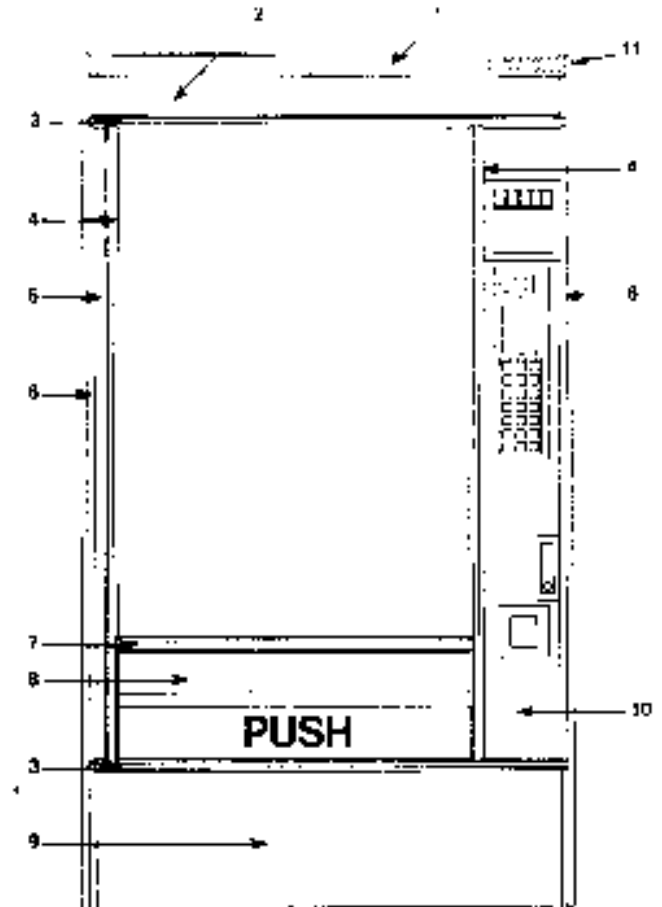

connectors



CABLE TIE
460044

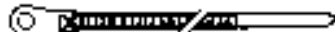

**MOUNTING TYPE
CABLE TIE**
380078



**ADHESIVE BACKED
CORD CLIP**
420097



**ADHESIVE BACKED
CABLE CLAMP**
420096



**FEMALE QUICK
DISCONNECT TERMINAL**
9/64 - 380213
3/16 - 380001
1/4 - 380003



**FEMALE PLUG
TERMINAL**
LARGE - 380004
SMALL - 380129



MALE PLUG TERMINAL
LARGE - 380005
SMALL - 380130



SQUARE PIN TERMINAL
LARGE - 380211
SMALL - 380208



**MOLEX MALE
CONNECTOR**
3 PIN - 380034
6 PIN - 380106



**MOLEX FEMALE
CONNECTOR**
2 PIN - 380189
3 PIN - 380035
6 PIN - 380107



**MAIN PRODUCT SHELF
RECEPTACLE**
380198

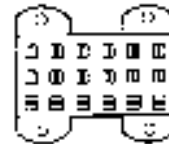

**MAIN PRODUCT SHELF
PLUG**
380197

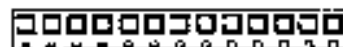

**AMP IN-LINE
CONNECTOR**
.156 CTRS.
7 PIN - 380210
18 PIN - 380210-1
13 PIN - 380210-2
17 PIN - 380210-3
19 PIN - 380210-4

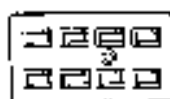

**CHANGER
RECEPTACLE
AND COVER**
18 PIN - 380199
COVER - 380125
12 PIN - 380200
COVER - 380201



**WIRE
CONNECTOR**
380214



CABLE CLAMP
3/8 DIA
420035-1

MOLEX CONNECTOR
.100 CTRS.
17 PIN - 380207



METAL CABLE CLAMP
420088

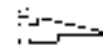

**CONNECTOR
POLARIZING KEY**
.100 CTRS - 380209
.156 CTRS - 380212